



Centrifuge 5430 / 5430 R

Operating manual

eppendorf



Copyright© 2008 Eppendorf AG, Hamburg. No part of this publication may be reproduced without the prior permission of the copyright owner.

Trademarks

eppendorf® and CombiSlide® are registered trademarks of Eppendorf AG, Hamburg, Germany.

Centriplus® is a registered trademark of Millipore Corporation, Billerica, USA.

Falcon® and Microtainer® are registered trademarks of Becton Dickinson, Franklin Lakes, NJ, USA.

Trademarks are not marked in all cases with ™ or ® in this manual.

Please find a detailed description of these figures in chapters 2.1 and 5.1 in your language.

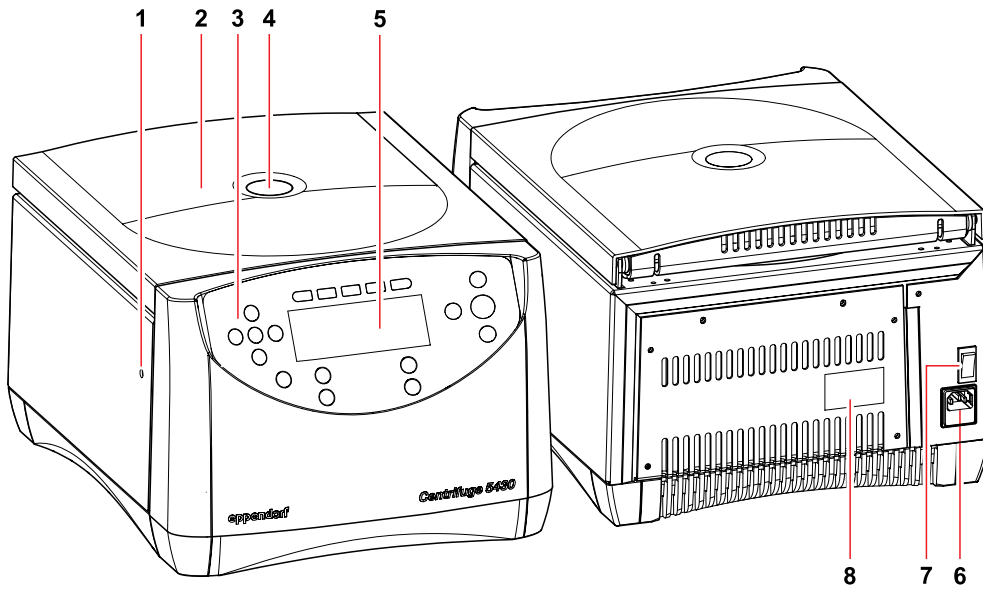

Fig. 1: Front and rear view of Centrifuge 5430

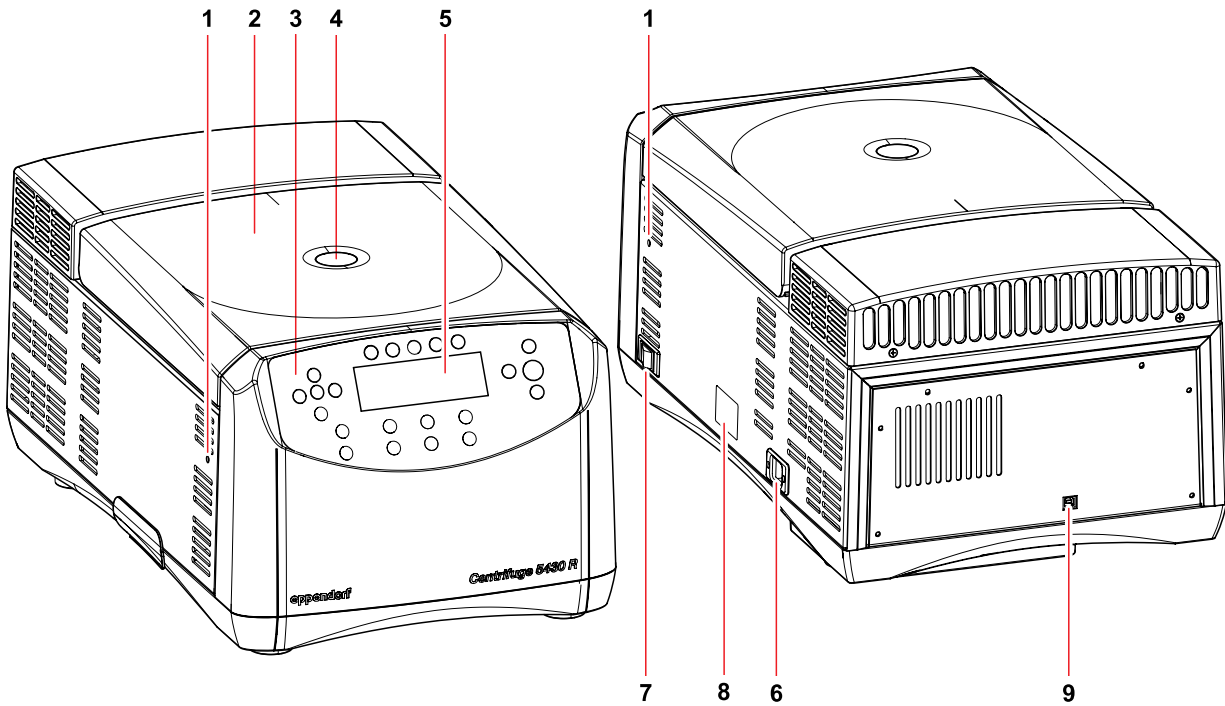

Fig. 2: Front and rear view of Centrifuge 5430 R

1 Emergency lid release	2 Centrifuge lid
3 Control panel	4 Window
5 Display	6 Mains connection
7 Mains switch	8 ID plate
9 USB port	

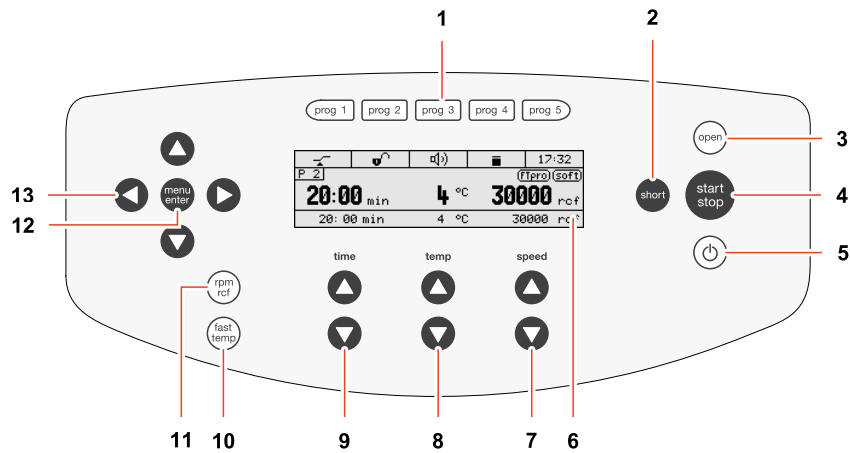

Fig. 3: Control panel and display of the Centrifuge 5430 / 5430 R (keypad version).

1 Select program	2 Short Spin centrifugation
3 Release lid	4 Start and stop centrifugation
5 Activate/deactivate standby mode	6 Display
7 Set the speed of centrifugation	8 Adjust the temperature (only 5430 R)
9 Adjust the centrifuging duration	10 Start the temperature control run Fast Temp (only 5430 R)
11 Switch the centrifuging speed displayed (rpm/rcf)	12 Call and select the menu parameters
13 Navigating the menu	

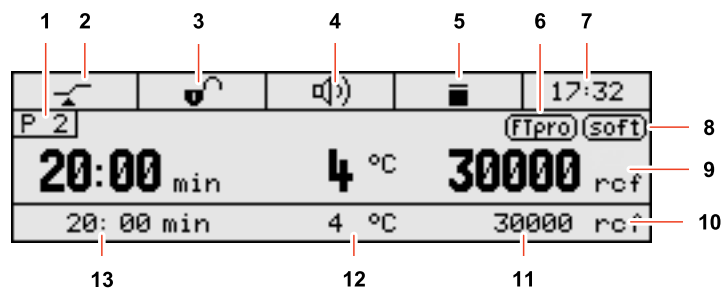

Fig. 4: Display of the Centrifuge 5430 / 5430 R

1 Program number (if enabled)	2 Status of the function At set rpm
3 Status of the key lock	4 Status of the loudspeaker
5 Status of the centrifuge	6 Temperature control run programming (only 5430 R)
7 Time	8 Soft ramp
9 Standard display	10 Extended display (if enabled)
11 g-force/speed	12 Temperature (only 5430 R)
13 Centrifuging duration	

Eppendorf Operating Manuals Feedback

We regularly assess our operating manuals. It is important that they meet your needs and expectations. As a user, your opinion is highly valued. Therefore you have the possibility to evaluate the quality of our operating manuals and to tell us your opinion. Please use our online questionnaire on www.eppendorf.com and receive ep-points as a small thankyou for your participation or send your replies to us either by fax or mail to:

Eppendorf AG
 Technical Writing / HH-UT
 D-22331 Hamburg

Fax: ++49 - 40 - 53 80 18 40

Which document do you refer to? Product: _____ Document ID: _____ (found on the second or last page of the manual, e.g. MixMate / B 5353 900.015-01/0506)	
Language of the manual:	
How often do you use this manual?	regularly <input type="radio"/> , frequently <input type="radio"/> , rarely <input type="radio"/> , never <input type="radio"/>
Please check, where applicable:	<input type="radio"/> : good <input type="radio"/> : average <input type="radio"/> : unsatisfactory <input type="radio"/> : don't know
1) Is the manual readily understandable?	<input type="radio"/> <input type="radio"/> <input type="radio"/> <input type="radio"/>
2) How do you find the structure of the manual?	<input type="radio"/> <input type="radio"/> <input type="radio"/> <input type="radio"/>
3) How easily can you find information? (by table of contents, index etc.)	<input type="radio"/> <input type="radio"/> <input type="radio"/> <input type="radio"/>
4) How useful are the figures?	<input type="radio"/> <input type="radio"/> <input type="radio"/> <input type="radio"/>
5) Would you like to have:	
• more figures	<input type="radio"/> <input type="radio"/> <input type="radio"/> <input type="radio"/>
• more text	<input type="radio"/> <input type="radio"/> <input type="radio"/> <input type="radio"/>
• no change	<input type="radio"/> <input type="radio"/> <input type="radio"/> <input type="radio"/>
6) How happy are you with the	
• print of the manual?	<input type="radio"/> <input type="radio"/> <input type="radio"/> <input type="radio"/>
• binding of the manual?	<input type="radio"/> <input type="radio"/> <input type="radio"/> <input type="radio"/>
• color of the manual?	<input type="radio"/> <input type="radio"/> <input type="radio"/> <input type="radio"/>
7) Remarks and suggestions (e.g. missing or too much content) as well as statements, particularly for critical ratings in 1) to 6).	
Job title:	E-Mail: (for possible further inquiries only)

Table of contents

1	User instructions	9
1.1	Using this manual	9
1.2	Warning signs and hazard icons	9
1.3	Symbols used	9
1.4	Abbreviations used	9
2	Product description	10
2.1	Main illustration	10
2.2	Delivery package	11
2.2.1	Centrifuge 5430	11
2.2.2	Centrifuge 5430 R	11
2.3	Features	12
2.4	Rotors	13
2.4.1	rcf display and calculation	15
3	Safety	16
3.1	Intended use	16
3.2	User profile	16
3.3	Application limits	16
3.3.1	Declaration concerning the ATEX directive (94/9/EC)	16
3.3.2	Maximum service life for accessories	16
3.4	Note on product liability	17
3.5	Warnings for intended use	17
3.5.1	Personal injury or damage to the equipment	17
3.5.2	Incorrect handling of the centrifuge	18
3.5.3	Incorrect handling of the rotors	19
3.5.4	Extreme strain on the centrifuging tubes	20
3.5.5	Aerosol-tight centrifugation	20
3.6	Safety instructions on the device	21
4	Installation	22
4.1	Selecting location	22
4.2	Preparing installation	22
4.3	Installing instrument	23
5	Operation	24
5.1	Overview of operating controls	24
5.2	Menu navigation	26
5.3	Configure centrifuge	26
5.3.1	Set menu language	26
5.3.2	Set date and time	27
5.4	Preparing for centrifugation	28
5.4.1	Switch on centrifuge	28
5.4.2	Inserting the rotor	28
5.4.3	Automatic rotor detection	28
5.4.4	Manual rotor detection	28
5.4.5	Load fixed-angle rotor	29
5.4.6	Load swing-bucket rotor	30
5.4.7	Close centrifuge lid	31
5.5	Cooling (only 5430 R)	32
5.5.1	Temperature adjustment	32
5.5.2	Temperature display	32
5.5.3	Temperature monitoring	32
5.5.4	Fast Temp	32
5.5.5	Fast Temp pro	33
5.5.6	Continuous cooling	34

Table of contents

5.6	Centrifuging	34
5.6.1	Centrifuging with time preset	35
5.6.2	Centrifuging in continuous operation	35
5.6.3	Short Spin centrifugation	36
5.6.4	Remove rotor	36
5.7	Standby mode	37
5.8	Usage notes for rotors	37
5.8.1	Rotor F-35-6-30: Rotor removal tool	37
5.8.2	Rotor A-2-MTP	38
5.8.3	Rotor FA-45-24-11-HS: Use the special rotor key	38
6	Operating controls and function	39
6.1	Device menu	39
6.2	Settings in the device menu	39
6.2.1	Programs	39
6.2.2	Use program keys	39
6.2.3	Other menu items	40
6.2.4	Settings	41
7	Maintenance	42
7.1	Prepare cleaning / disinfection	42
7.2	Perform cleaning/disinfecting	42
7.3	Additional service instructions for Centrifuge 5430 R	44
7.4	Glass breakage	44
7.5	Fuses	44
7.5.1	Centrifuge 5430	44
7.5.2	Centrifuge 5430 R	44
7.6	Decontamination before shipping	45
8	Troubleshooting	46
8.1	General errors	46
8.2	Error messages	46
8.3	Open centrifuge in the event of a power failure	48
9	Transport, storage and disposal	49
9.1	Transport	49
9.2	Storage	49
9.3	Disposal	49
10	Technical data	50
10.1	Power supply	50
10.1.1	Centrifuge 5430	50
10.1.2	Centrifuge 5430 R	50
10.2	Ambient conditions	50
10.3	Weight / dimensions	51
10.3.1	Centrifuge 5430	51
10.3.2	Centrifuge 5430 R	51
10.4	Application parameters	51
11	Ordering information	52
11.1	Centrifuge 5430	52
11.2	Centrifuge 5430 R	53
11.3	Accessories	54
11.3.1	Rotors and rotor lids	54
11.3.2	Adapters	55
11.3.3	Other accessories	55
11.3.4	Fuses for Centrifuge 5430	55





1 User instructions

1.1 Using this manual

- ▶ Before using the device for the first time, please read the operating manual.
- ▶ Please view this operating manual as part of the product and keep it somewhere easily accessible.
- ▶ When forwarding the appliance to third parties, be sure to include these operating manual.
- ▶ If this manual is lost, please request another one. The current version can be found on our website, www.eppendorf.com (International) or www.eppendorfna.com (North America).

The Centrifuge 5430 / 5430 R is available in two versions: **Keypad** or **Dials**. This operating manual generally describes how to operate the keypad version. However, it also applies to the dial version.

1.2 Warning signs and hazard icons

Depiction	Meaning
	DANGER Risk of electric shock with potential for severe injury or death as a consequence.
	DANGER Risk of explosion with potential for severe injury or death as a consequence.
	DANGER Bio hazard with potential for risk to health or death as a consequence.
	WARNING Warning of potential injury or health risk.
	CAUTION Refers to risk of damage to property.
	Refers to particularly useful information and tips.

1.3 Symbols used

Depiction	Meaning
▶	You are requested to perform an action.
1. 2.	Perform these actions in the sequence described.
•	List.
 (Example)	Press this key to carry out the described activity.
Text	Terms from the device display.

1.4 Abbreviations used

MTP	Microplate
PCR	Polymerase Chain Reaction
PTFE	Polytetrafluorethylene
rcf	Relative centrifugal force (g-force, RCF)
rpm	Revolutions per minute
UV	Ultraviolet radiation

2 Product description

2.1 Main illustration

The depiction of the front and rear view of the Centrifuge 5430 / 5430 R can also be found on the front fold-out page (see Fig. 1 and Fig. 2).

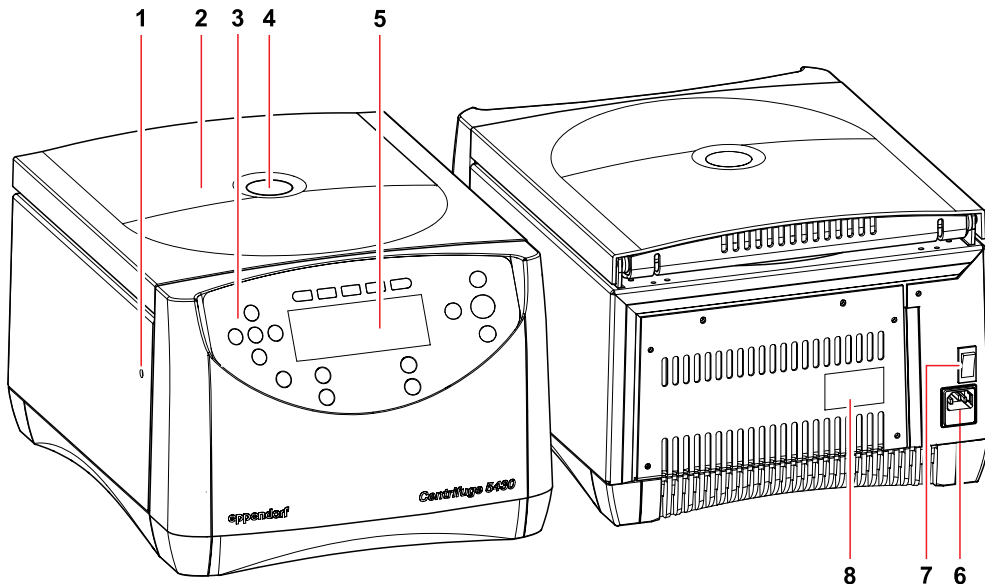

Fig. 1: Front and rear view of Centrifuge 5430

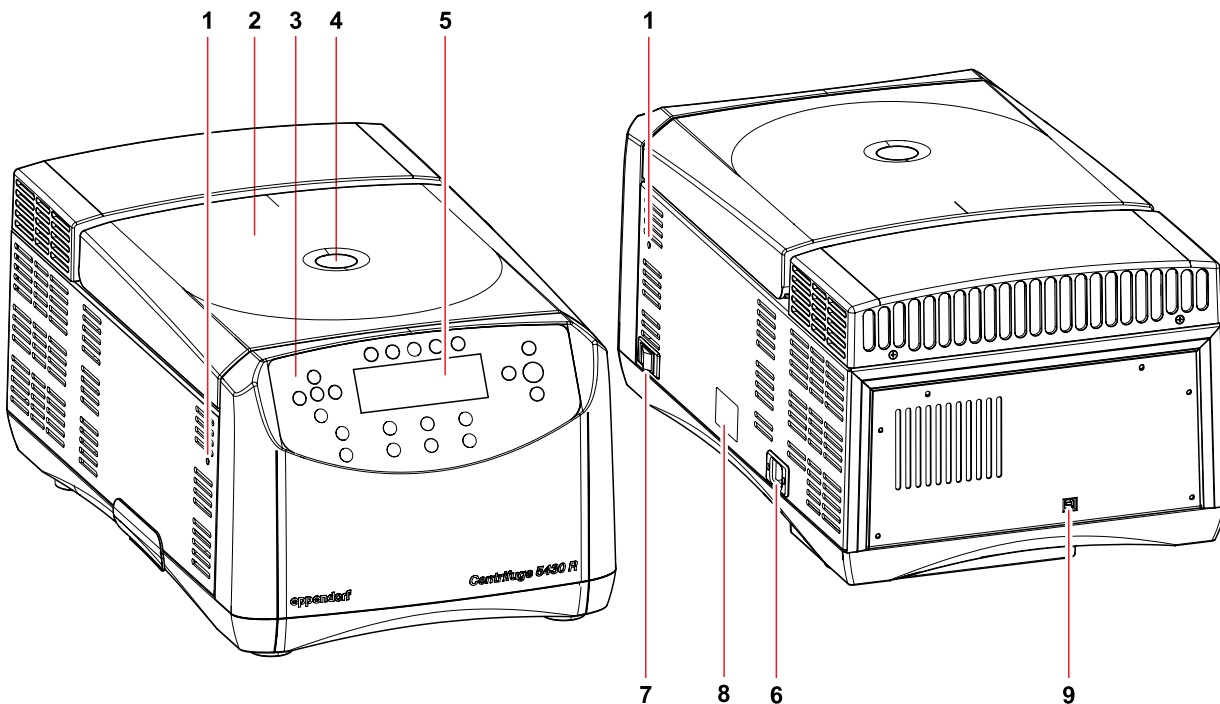

Fig. 2: Front and rear view of Centrifuge 5430 R

2 Product description

1 Emergency lid release On both sides of the device (see <i>Open centrifuge in the event of a power failure</i> on page 48).	2 Centrifuge lid
3 Control panel Keys and dials (dependent on the device version) for operating the centrifuge (see p. 24).	4 Window Visual control for rotor stop or option for speed check via stroboscope.
5 Display Depiction of the current centrifuging parameters and device settings (see p. 24).	6 Mains connection Connection socket for the mains cable supplied. Only 5430: The fuse holder is located beneath (see <i>Fuses</i> on page 44).
7 Mains switch Switch for switching the device on and off. Switch position 0: The device is switched off. Switch position I: The device is switched on.	8 ID plate
9 USB port Interface for error analysis and software updates by the Technical Service.	

2.2 Delivery package

2.2.1 Centrifuge 5430

Quantity	Order No. (International)	Order No. (North America)	Description
1	-	-	Centrifuge 5430 see chapter <i>Ordering information</i> for the respective device version, configuration and order number
1 or	5301 850.249 5427 850.341	022654403 022654381	Fuses 2 x 4.0 AT (230 V) 2 x 8.0 AT UL (120 V / 100 V)
1	5416 301.001	022634305	Rotor key Standard
1	5703 350.102	022639609	Captain Eppi rotor key holder 1 piece
1	-	-	Mains cable
1	5427 900.012	5427900012	Centrifuge 5430/5430 R Operating manual, multi-lingual

2.2.2 Centrifuge 5430 R

Quantity	Order No. (International)	Order No. (North America)	Description
1	-	-	Centrifuge 5430 R see chapter <i>Ordering information</i> for the respective device version, configuration and order number
1	5416 301.001	022634305	Rotor key Standard
1	5703 350.102	022639609	Captain Eppi rotor key holder 1 piece
1	-	-	Mains cable
1	5427 900.012	5427900012	Centrifuge 5430/5430 R Operating manual, multi-lingual

2 Product description

2.3 Features

The versatile Centrifuge 5430 / 5430 R has a capacity of 30 x 2.0 ml and reaches max. 30.130 x g / 17,500 rpm. The versatility is reflected in the available rotor options. You can select between eight different rotors to centrifuge the following tubes for your various applications:

- Micro test tubes (0.2 to 2.0 mL)
- PCR strips
- Microtainers
- Spin Columns
- Cryo tubes
- Falcon tubes (15/50 mL)
- Micro test plates
- PCR plates
- Deepwell plates (max. height 29 mm)
- Slides (with CombiSlide adapter)

Five program keys for rapid loading and saving of parameters, as well as another 45 program places, a large display and menu-controlled operation all make it easier to use the centrifuge. The Centrifuge 5430 / 5430 R has been designed based on latest ergonomic studies. This facilitates an intuitive and easy operation.

The Centrifuge 5430 / 5430 R is available with two different control panels: An easy clean keypad or blue dials for quickly setting the centrifugation parameters.

Centrifuge 5430 R has an additional temperature control function for centrifugation between -11 °C and +40 °C. Use the **Fast Temp** function to start a temperature control run without samples to adjust the rotor chamber incl. rotor, buckets and adapters quickly to the set target temperature. This temperature control run can also be started automatically at specified times using the **Fast Temp pro** function.

2 Product description

2.4 Rotors

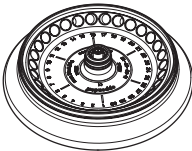
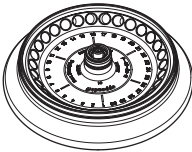
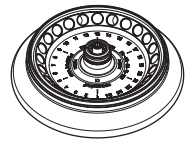
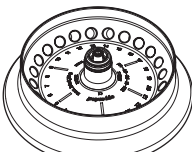

You can operate the Centrifuge 5430 / 5430 R with the following rotors. Before using sample tubes, please note the manufacturer's specifications with regard to centrifugation resistance (max. rcf).

	Max. capacity	Max. g-force (rcf) / speed (rpm) w/o adapter	Max. load per rotor bore ⁽¹⁾	Notes
		Acceleration / braking time ⁽²⁾ (SOFT): With soft ramp		
Rotor FA-45-30-11 	30 micro test tubes @ 1.5/2.0 mL With adapters: <ul style="list-style-type: none"> • 0.2 mL PCR tubes • 0.4 mL micro test tubes • 0.5 mL micro test tubes • 0.6 mL Microtainers 	20,817 x g / 14,000 rpm 14 s / 15 s 60 s / 65 s (SOFT)	3.75 g	<ul style="list-style-type: none"> • PTFE-coated (particularly resistant to chemicals), marked: <i>coated</i>. • Aerosol-tight⁽³⁾ rotor lid (aluminum). • Spin Columns possible, better with rotor FA-45-24-11-Kit.
Rotor F-45-30-11 	30 micro test tubes @ 1.5/2.0 mL With adapters: <ul style="list-style-type: none"> • 0.2 mL PCR tubes • 0.4 mL micro test tubes • 0.5 mL micro test tubes • 0.6 mL Microtainers 	20,817 x g / 14,000 rpm 14 s / 15 s 60 s / 65 s (SOFT)	3.75 g	<ul style="list-style-type: none"> • PTFE-coated (particularly resistant to chemicals), marked: <i>coated</i>. • Spin Columns possible, better with rotor FA-45-24-11-Kit.
Rotor FA-45-24-11-HS 	24 micro test tubes @ 1.5/2.0 mL With adapters: <ul style="list-style-type: none"> • 0.2 mL PCR tubes • 0.4 mL micro test tubes • 0.5 mL micro test tubes • 0.6 mL Microtainers 	30,130 x g / 17,500 rpm 21 s / 16 s 60 s / 65 s (SOFT)	3.75 g	<ul style="list-style-type: none"> • Max. g-force/speed (30.130 x g / 17,500 rpm) only with tubes approved for this use by the manufacturer. • PTFE-coated (particularly resistant to chemicals), marked: <i>coated</i>. • Aerosol-tight⁽³⁾ rotor lid (aluminum). • Spin Columns possible, better with rotor FA-45-24-11-Kit. • Tightening and undoing the rotor only with the special rotor key for rotor FA-45-24-11-HS (see p. 38).
Rotor FA-45-24-11-Kit 	24 Spin Columns or 1.5/2.0 mL micro test tubes With adapters: <ul style="list-style-type: none"> • 0.2 mL PCR tubes • 0.4 mL micro test tubes • 0.5 mL micro test tubes • 0.6 mL Microtainers 	19,090 x g / 13,200 rpm 14 s / 16 s 68 s / 90 s (SOFT)	3.75 g	<ul style="list-style-type: none"> • Particularly high edge for all commercially available Spin Columns. See the note about centrifugation with open tube lids in this connection (see <i>Load fixed-angle rotor</i> on page 29). • Aerosol-tight⁽³⁾ rotor lid (aluminum).

2 Product description

EN

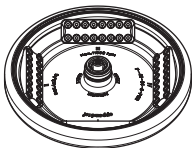
Operating Manual

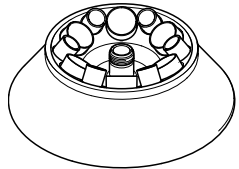
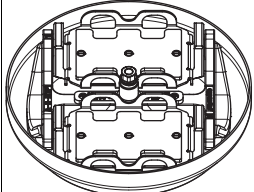
	Max. capacity	Max. g-force (rcf) / speed (rpm) w/o adapter	Max. load per rotor bore ⁽¹⁾	Notes
		Acceleration / braking time ⁽²⁾ (SOFT): With soft ramp		
Rotor F-45-64-5-PCR 	64 PCR tubes (0.2 mL) or eight 5-tube or 8-tube PCR strips, each with the enclosed adapters.	13,543 x g / 11,800 rpm	3.4 g (excl. adapter)	
		12 s / 15 s 60 s / 65 s (SOFT)		
Rotor F-45-18-17-Cryo 	18 Cryo tubes or 18 sealable centrifugation tubes, max. Ø: 16.9 mm. With supplied adapters: max. Ø: 13.4 mm, max. tube length: 50 mm.	8,324 x g / 8,900 rpm	8.7 g	<ul style="list-style-type: none"> The g-force/speed is always set in 10 x g or 10 rpm increments.
		8 s / 11 s 67 s / 85 s (SOFT)		
Rotor F-35-6-30 	6 x 50 mL Falcon tubes with or without a standing edge or 6 x 15mL Falcon tubes, each with supplied adapters or 6 Centriplus centrifuge filter units with adapters.	7,197 x g / 7,830 rpm	110 g	<ul style="list-style-type: none"> Removal and insertion of the rotor only with removal tool supplied.
		23 s / 23 s 60 s / 67 s (SOFT)		
Rotor A-2-MTP 	Two buckets to hold <ul style="list-style-type: none"> Micro test plates cell culture plates PCR plates Deepwell plates (max. height 29 mm) Slides (with CombiSlide adapter) 	2,204 x g / 4,680 rpm	170 g (per bucket)	<ul style="list-style-type: none"> Centrifuging of PCR plates only with appropriate adapters. Max. loading height: 29 mm. Only 5430 R: More efficient cooling by centrifugation without wind shield upper shell (see <i>Load swing-bucket rotor</i> on page 30).
		17 s / 21 s 62 s / 67 s (SOFT)		

(1) Maximum load per rotor bore for adapter + tube + content.

(2) According to DIN 58 970 (device version: 230 V and 120 V, 50 to 60 Hz).

(3) Aerosol impermeability tested and certified by the Centre of Emergency Preparedness and Response, Health Protection Agency, Porton Down (UK) (see certificates at the end of this operating manual).

For the rotors and rotor lids labeled *coated* color fluctuations may occur as a result of the production process. These fluctuations have no effect on service life or resistance to chemicals.

Rotor code:

All Eppendorf® rotors are identified using a simple, alphanumeric format that represents the technical specifications in a uniform series of letters and numbers.

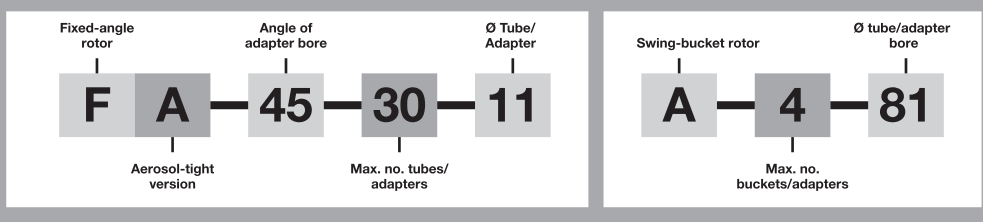

2 Product description

2.4.1 rcf display and calculation



Use the **rpm/rcf** key to switch the display of centrifugation speed between **rpm** (rpm) and **g-force** (rcf). Ensure that the g-force displayed on switching is standardized to suit the rotor in question without an adapter. When adapters are used, you can achieve the following maximum g-forces (rcf) at maximum speed:

Rotor	Adapter	Max. centrifuging radius r_{\max} [cm]	Max. g-force (rcf)
FA-45-30-11 / F-45-30-11	without adapter	9.5	20.817
	for 0.2 mL PCR tubes	7.4	16.215
	for 0.4 mL micro test tubes	9.5	20.817
	for 0.5 mL micro test tubes	8.4	18.407
	for 0.6 ml Microtainers	9.5	20.817
FA-45-24-11-HS	without adapter	8.8	30.130
	for 0.2 mL PCR tubes	6.7	22.940
	for 0.4 mL micro test tubes	8.8	30.130
	for 0.5 mL micro test tubes	7.7	26.364
	for 0.6 ml Microtainers	8.8	30.130
FA-45-24-11-Kit	without adapter	9.8	19.090
	for 0.2 mL PCR tubes	7.7	15.000
	for 0.4 mL micro test tubes	9.8	19.090
	for 0.5 mL micro test tubes	8.7	16.950
	for 0.6 ml Microtainers	9.8	19.090
F-45-64-5-PCR	for PCR strips, inside	7.7	11.987
	for PCR strips, outside	8.7	13.543
F-45-18-17-Cryo	without adapter	9.4	8.320
	for Cryo tubes	9.0	7.970
F-35-6-30	for 15 ml Falcon tubes	10.5	7.197
	for 50 ml Falcon tubes	10.5	7.197
	for Centriplus centrifuge filter units	11.4	7.184
A-2-MTP	without adapter	9.0	2.204
	for 384 well PCR plates	7.7	1.885
	for 96 well PCR plates	7.3	1.788
	CombiSlide adapter	7.7	1.885

To determine g-force (rcf) for a specific adapter, you can calculate as per DIN 58 970 using the following formula:

$$\text{rcf} = 1.118 \cdot 10^{-5} \cdot n^2 \cdot r_{\max}$$

n: speed in rpm

r_{\max} : max. centrifuging radius in cm

Example

In rotor FA-45-30-11, the 0.5 mL adapter has a maximum radius of 8.4 cm. At 7.000 rpm a maximum g-force of 4,600 x g is reached.

3 Safety

3.1 Intended use

The Centrifuge 5430 / 5430 R is intended exclusively for use indoors and is for separating aqueous solutions and suspensions of differing density in approved test tubes.



Warning! Poor safety due to incorrect accessories and spare parts.

The use of accessories and spare parts other than those recommended by Eppendorf may impair the security, function and precision of the device. Eppendorf accepts no warranty or liability for damage caused by third-party parts or incorrect use.

- ▶ Use only original accessories recommended by Eppendorf.

3.2 User profile

This device may only be operated by trained specialist staff. They must have carefully read the operating manual and be familiar with the function of the device.

3.3 Application limits

3.3.1 Declaration concerning the ATEX directive (94/9/EC)



Risk of explosion!

- ▶ Do not operate the device in rooms where work is being carried out with explosive substances.
- ▶ Do not use this device to process any explosive or highly reactive substances.
- ▶ Do not use this device to process any substances which could create an explosive atmosphere.

The Centrifuge 5430 / 5430 R due to its current design and the environmental conditions on the inside of the device, is currently not suitable for use in a potentially explosive atmosphere.

The device must therefore only be used in a safe environment, such as in the open environment of a ventilated laboratory or an extractor hood. The use of substances which may contribute to a potentially explosive atmosphere is not permitted. The final decision with regard to the risks connected with the use of such substances is the responsibility of the user.

3.3.2 Maximum service life for accessories



Warning! Risk of injury from chemically or mechanically damaged accessories.

Even minor scratches and cracks can result in serious internal material damage.

- ▶ Protect all parts from mechanical damage.
- ▶ Check accessories regularly.
- ▶ Do not use rotors, rotor lids or buckets with signs of corrosion or mechanical damage (e.g. deformations).
- ▶ Do not use accessories whose maximum useful life has been exceeded.
- ▶ When inserting the buckets in the swing-bucket rotor, ensure that they do not become scratched.

3 Safety

Rotor/accessories	Maximum service life from first commissioning
Rotor A-2-MTP including associated buckets and the wind shield upper shell	7 years
Transparent polypropylene rotor lids	3 years
Plastic adapters	1 year

For the other rotors described here and their rotor lids (see *Rotors* on page 13) there is no limit for their service life, as long as the following conditions are met: proper use, recommended maintenance and undamaged condition.

The date of manufacture is stamped onto the rotors in the format *03/07* (= March 2007) and/or on the inside of the plastic rotor lids in the form of a clock ⌚. This is for information only and does not have any reference to the service life.

3.4 Note on product liability

In the following cases the protection provided in the device may be impaired. The liability for the function of the device passes to the operator if:

- The device is not used in accordance with the operating manual.
- The device is used outside the range of application described herein.
- The device is used with accessories or consumables (e.g. tubes and plates) which are not recommended by Eppendorf.
- The device is maintained or repaired by persons not authorized by Eppendorf.
- The owner has made unauthorized modifications to the device.

3.5 Warnings for intended use

Read the operating manual first and observe the following general safety instructions before using the Centrifuge 5430 / 5430 R.

3.5.1 Personal injury or damage to the equipment



Danger! Electric shock from damage to device/power cable.

- ▶ Only switch on the device if the device and the power cable are undamaged.
- ▶ Only use devices that have been properly installed or repaired.



Danger! Lethal voltages inside the device.

- ▶ Ensure that the housing is always closed and undamaged so that no parts inside the device can be contacted by accident.
- ▶ Do not remove the housing of the device.
- ▶ Do not allow the device to be opened by anyone except service personnel who have been specifically authorized by Eppendorf.



Warning! Risk from incorrect supply voltage

- ▶ Only connect the device to power sources that match the electrical specifications on the device ID plate.

3 Safety



Warning! Risk when handling toxic liquids and pathogenic microorganisms.

- ▶ Observe the corresponding national regulations when handling toxic liquids and pathogenic microorganisms of risk category II (see World Health Organization: Laboratory Biosafety Manual).
- ▶ For the centrifugation of these substances, use aerosol-tight closure systems.
- ▶ When working with pathogenic microorganisms belonging to a higher risk group, more than one aerosol-tight bioseal must be provided for.



Warning! Centrifuge lid can crush. Keep hands clear.

- ▶ When opening or closing the device lid, do not reach between the device and lid or into the latching mechanism of the lid.
- ▶ Always open the centrifuge lid completely to prevent it from falling closed.

Caution! Damage to device by spilling liquids in the rotor or rotor chamber

1. Switch the device off.
2. Disconnect the device from the power supply.
3. Clean the device and the accessories carefully in accordance with the cleaning and disinfection instructions in the operating manual.
4. If a different cleaning and disinfecting method is to be used, contact Eppendorf AG to ensure that the intended method will not damage the device.

Caution! Damage to electronic components through formation of condensate.

After the device has been moved from a cool to a warmer environment, formation of condensation can occur inside the device.

- ▶ Let the device warm up after transport for a minimum of three hours, before connecting it to the power supply
- ▶ or, let it run for half an hour just before a short transport.

Caution! Centrifuge 5430 R: Compressor damage after improper transport.

- ▶ Only switch on the centrifuge 4 hours after installation.

Caution! Lack of safety due to missing operating manual.

- ▶ When passing on the device, always enclose the operating manual.
- ▶ If you lose the operating manual, request a replacement. The current version of the operating manual and the safety instructions can also be found on our website www.eppendorf.com.

3.5.2 Incorrect handling of the centrifuge



Warning! Damage from knocking against or moving the device during operation.

- ▶ Do not move or knock against the device during operation.

3 Safety

3.5.3 Incorrect handling of the rotors



Warning! Risk of injury from improperly attached rotors and rotor lids.

- ▶ Centrifuge only with the rotor and rotor lid firmly tightened.
- ▶ If unusual noises occur when the centrifuge starts, the rotor or the rotor lid may not be properly secured. Stop centrifugation immediately by pressing the **start/stop** key.



Warning! Risk of injury from unsymmetric loading of rotors.

- ▶ Load rotors symmetrically with identical tubes and/or buckets and plates.
- ▶ Only load adapters with suitable tubes and/or plates.
- ▶ Always use tubes and/or plates of the same type (weight, material/density and volume).
- ▶ Check for symmetric loading by ensuring the adapters and tubes and/or plates used are even with scales.

The device automatically detects imbalances during operation and stops centrifugation immediately with an error message and a signal tone. Check the loading, balance the tubes and restart the centrifugation.



Caution! Risk of injury from overloaded rotor.

The Centrifuge 5430 / 5430 R is designed for the centrifugation of material with a max. density of 1.2 g/ml at maximum speed and volume and/or load.

- ▶ Observe the information on each rotor relating to maximum load (adapter, tube and contents) per rotor bore/per bucket and do not exceed.



Warning! Risk of injury from chemically or mechanically damaged accessories.

Even minor scratches and cracks can result in serious internal material damage.

- ▶ Protect all parts from mechanical damage.
- ▶ Check accessories regularly.
- ▶ Do not use rotors, rotor lids or buckets with signs of corrosion or mechanical damage (e.g. deformations).
- ▶ Do not use accessories whose maximum useful life has been exceeded.
- ▶ When inserting the buckets in the swing-bucket rotor, ensure that they do not become scratched.



Warning! Damage to rotors from aggressive chemicals.

Rotors are high-quality components which withstand extreme stresses. This stability can be impaired by aggressive chemicals.

- ▶ Avoid the use of aggressive chemicals, including strong and weak alkali, strong acids, solutions with mercury, copper and other heavy metal ions, halogenated hydrocarbons, concentrated saline solutions and phenol.
- ▶ If the rotor is contaminated by aggressive chemicals, clean it immediately using a neutral cleaning agent. This applies to the rotor bores in particular.

Caution! If handled incorrectly, the rotor can fall over.

The rotor buckets A-2-MTP must not be used as a handle.

- ▶ Before moving the rotor, remove the buckets.
- ▶ Always pick up the rotor at the rotor cross, using both hands.

3 Safety

3.5.4 Extreme strain on the centrifuging tubes



Warning! Risk of injury from overloaded tubes.

- ▶ Note the loading limits specified by the tube manufacturer.
- ▶ Only use tubes which are approved by the manufacturer for the required rcf .

Caution! Risk from damaged tubes.

Damaged tubes must not be used, as this could cause further damage to the device and the accessories and loss of the samples.

- ▶ Before use, carry out a visual check of all tubes for any damage.

Caution! Risk from open tube lids.

Open tube lids can break off during centrifugation and cause damage to the rotor as well as to the centrifuge.

- ▶ Carefully seal all tube lids before centrifuging.

Exception: Note the information on the centrifugation of Spin Columns in the rotor FA-45-24-11-Kit (see *Load fixed-angle rotor* on page 29).

Caution! Hazard to plastic tubes from organic solvents.

When using organic solvents (e.g. phenol, chloroform) the density of plastic tubes is reduced, i.e. the tubes could get damaged.

- ▶ Follow the manufacturer's information about the chemical resistance of tubes.

Caution! Sample tubes heat up.

In uncooled centrifuges the temperature in the rotor chamber, rotor and sample can rise to above 40 °C dependent on the run time, g-force (rcf) / speed and ambient temperature:

- ▶ Note that this can reduce the centrifugation resistance of the sample tubes.
- ▶ Note the temperature resistance of your samples.

3.5.5 Aerosol-tight centrifugation



Warning! Aerosol-tightness limited if the incorrect rotor/rotor lid combination is used.

Aerosol-tight centrifugation is guaranteed only if the rotors and rotor lids intended for this purpose are used. These are always indicated by the prefix **FA**.

The aerosol-tight rotors and rotor lids of this centrifuge are additionally marked with a red ring on the rotor and a red rotor lid screw.

- ▶ Always use rotors and rotor lids marked aerosol-tight together for aerosol-tight centrifugation.
- ▶ Only use aerosol-tight rotor lids in combination with rotors which are marked on the rotor lid.



Warning! Aerosol-tightness limited in the event of incorrect use.

Autoclaving, mechanical stresses and contamination by chemicals or other aggressive solvents can impair the aerosol-tightness of the rotors and rotor lid.



- ▶ Regularly check that the seals of aerosol-tight rotor lids are undamaged.
- ▶ Only use aerosol-tight rotor lids with undamaged and clean gaskets.
- ▶ Thinly brush the threads of the rotor lid screw after every proper autoclaving (121 °C, 20 min.) with pivot grease (order no. Int.: 5810 350.050 / North America: 022634330). Do not apply the pivot grease to the gaskets. Replace the aerosol-tight rotor lids after 10 autoclave cycles.
- ▶ Aerosol-tight rotors should never be stored with rotor lids screwed on tightly.

3 Safety

EN

Operating Manual

3.6 Safety instructions on the device

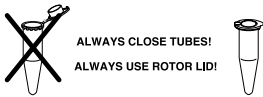
Depiction	Meaning	Location
	WARNING General hazard point. Follow the operating manual.	5430: Device back 5430 R: Right device side
	CAUTION Always tighten up the rotor using the rotor key supplied.	Top of device, below the centrifuge lid.
	CAUTION Close all tubes and use a rotor lid.	Top of device, below the centrifuge lid.

4 Installation

4.1 Selecting location



Warning! If a fault occurs, objects in the immediate vicinity of the devices could get damaged.

- ▶ In accordance with the recommendations of EN 61010-2-020, leave a safety distance of **30 cm** clear around the device during operation.



Warning! Risk in the event of a fault.

- ▶ Install an emergency switch away from the device so that it can be isolated from the power supply if a fault occurs. The emergency switch should ideally be situated outside of the laboratory or near its exit.

Select the location for the device according to the following criteria:

- Suitable power connection as per the nameplate (230 V/120 V/100 V).
- Stable, horizontal and resonance-free lab bench. Weight of the device: 29 kg (5430) or 56 kg (5430 R).
- **At least 30 cm** distance to adjoining devices on the sides and **a minimum of 15 cm** at the rear to the wall.
- A well ventilated environment which is protected from direct sunlight to prevent the device from heating up more.

4.2 Preparing installation

Requirement

The weight of the centrifuge is 29 kg (5430) or 56 kg (5430 R). For unpacking and installation the assistance of another person is required.



Retain the packaging material and the transport protection device for subsequent transport or storage. See also the instructions relating to transport. (see p. 49).

- ▶ Perform the following steps in the sequence described.

Centrifuge 5430	Centrifuge 5430 R
<ol style="list-style-type: none"> 1. Open the carton. 2. Remove the covering cardboard. 3. Remove accessories. 4. Grip from the strap retainers and have two persons lift the centrifuge out of the box. 5. Pull off the strap retainers, do not cut. 6. Remove the front and rear transport securing devices from the centrifuge. 7. Remove the plastic sleeve. 8. Carefully lift the centrifuge on one side and pull off the transport securing device of the motor on the underside of the centrifuge. 	<ol style="list-style-type: none"> 1. Open the carton. 2. Remove accessories. 3. Lift and remove the front and rear transport securing devices. 4. Grip from the textile straps and have two persons lift the centrifuge out of the box. 5. Pull off the textile straps, do not cut. 6. Remove the plastic sleeve.

4 Installation

4.3 Installing instrument

Caution! Centrifuge 5430 R: Compressor damage after improper transport.

- ▶ Only switch on the centrifuge 4 hours after installation.
-

Perform the following steps in the sequence described.

1. Place the device on a suitable lab bench.
Only 5430 R: Do not use the opening for the tray for condensation water as a handle.
 2. Allow the device to warm up for at least 3 hours (Centrifuge 5430) or 4 hours (Centrifuge 5430 R) to the ambient temperature to prevent damage to the electronic components from condensation and damage to the compressor (Centrifuge 5430 R).
 3. Check that the mains voltage and frequency match the requirements on the device type plate.
 4. Connect the centrifuge to the mains and switch it on using the mains power switch on the rear of the device (Centrifuge 5430) or at the right side of the device (Centrifuge 5430 R).
 - Standby key  lights green.
 - Display is active.
 - **Only 5430:** Lid opens automatically
 5. **Only 5430:** Remove the transport securing device of the motor shaft.
 6. If the scope of delivery includes a rotor, undo and remove this with the aid of the rotor key supplied.
 7. **Only 5430:** Remove the transport securing device of the air guide ring.
 8. Use the details included in the scope of delivery to check that the delivery is complete.
 9. Check all parts for any transport damage. Contact your dealer if any damage is found.
-



Retain the packaging material and the transport protection device for subsequent transport or storage. See also the instructions relating to transport. (see p. 49).

5 Operation

5.1 Overview of operating controls

The Centrifuge 5430 / 5430 R is available in two versions: **Keypad** or **Dials**. This operating manual generally describes how to operate the keypad version. However, it also applies to the dial version.

Prior to the first use of the Centrifuge 5430 / 5430 R familiarize yourself with the control elements and the display.

The depiction of the control panel and the display of the Centrifuge 5430 / 5430 R can also be found on the front fold-out page (see Fig. 3 and Fig. 4).

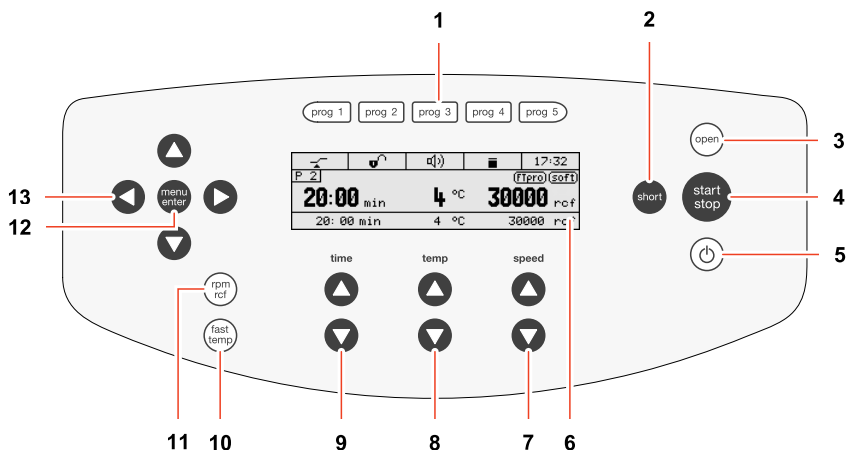

Fig. 3: Control panel and display of the Centrifuge 5430 / 5430 R (keypad version).

<p>1 Select program Press briefly: load the stored centrifuging parameters. Press and hold (> 2 sec): save the current centrifuging parameters (see p. 39).</p>	<p>2 Short Spin centrifugation (see p. 36)</p>
<p>3 Release lid</p>	<p>4 Start and stop centrifugation</p>
<p>5 Activate/deactivate standby mode Key lights green: centrifuge is ready for operation. Key lights red: standby mode active (see p. 37).</p>	<p>6 Display</p>
<p>7 Set the speed of centrifugation Dependent on device version designed as key or dial.</p>	<p>8 Adjust the temperature (only 5430 R)</p>
<p>9 Adjust the centrifuging duration Dependent on device version designed as key or dial.</p>	<p>10 Start the temperature control run Fast Temp (only 5430 R) (see p. 32)</p>
<p>11 Switch the centrifuging speed displayed (rpm/rcf)</p>	<p>12 Call and select the menu parameters (see p. 39)</p>
<p>13 Navigate the menu (see p. 26)</p>	

5 Operation

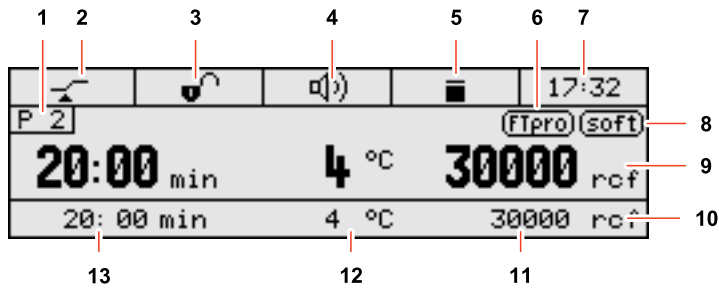

Fig. 4: Display of the Centrifuge 5430 / 5430 R

<p>1 Program number (if enabled)</p>	<p>2 Status of the function At set rpm ↗: Start of operation when reaching 95% of the preset g-force (rcf) or speed. ↘: Start of operation immediately.</p>
<p>3 Status of the key lock 🔒: Centrifuging parameters cannot be modified unintentionally. 🔓: No key lock.</p>	<p>4 Status of the loudspeaker 🔊: Switched on. 🔇: Switched off.</p>
<p>5 Status of the centrifuge 🚪: Centrifuge lid unlatched. 🚪: Centrifuge lid latched. 🔄 (flashing): Centrifuging in progress.</p>	<p>6 Temperature control run programming (only 5430 R) FTpro: Fast Temp pro is enabled, i.e. start time and temperature of the temperature control run have been programmed (see p. 33).</p>
<p>7 Time</p>	<p>8 Soft ramp soft: Rotor accelerates and brakes slowly. No symbol: Rotor accelerates and brakes rapidly.</p>
<p>9 Standard display</p>	<p>10 Extended display (if enabled)</p>
<p>11 g-force/speed</p>	<p>12 Temperature (only 5430 R)</p>
<p>13 Centrifugation duration</p>	

Please also read the precise description of the individual functions (see p. 39).

5 Operation

5.2 Menu navigation

The menu consists of two levels. To change settings, generally proceed as follows.

1.  Open menu.

2.  Select the desired menu item.

3.  Confirm selection.

4.  Select the setting of the parameters in question.

5.  Confirm changed setting.
A tick appears in front of the confirmed setting.

6.  Keep pressing the key until you reach the desired menu level or exit the menu.
Some menus can only be exited by selecting and confirming the menu item **Back / Zurück / Retour / Atrás**

5.3 Configure centrifuge

5.3.1 Set menu language

Proceed as follows to set menu language.

1.  Open menu.

2.  Select **Settings**.

3.  Confirm selection.

4.  Select **Language**.

5.  Confirm selection.

6.  Select **English, Deutsch, Francais** or **Espanol**.













7.  Confirm selection. A tick appears in front of the selected language. The setting takes effect immediately.

8.  Press key several times to exit the menu.

5 Operation

5.3.2 Set date and time

Proceed as follows to set date and time.

1.  Open menu.
2.  Select **Settings**.
3.  Confirm selection.
4.  Select **Date/time**.
5.  Confirm selection.
6.  Set date.
7.  Confirm setting.
8.  Set time format (12 h / 24 h).
9.  Confirm setting.
10.  Set time.
11.  Confirm setting.
12.  Press key several times to exit the menu.



There is no automatic switch between summer time and winter time.

5 Operation

5.4 Preparing for centrifugation

5.4.1 Switch on centrifuge

1. Switch on the centrifuge using the mains power switch or the standby key (☺).
Only 5430: After switching on at the mains power switch, the centrifuge lid opens automatically.
2. Open the closed centrifuge lid by pressing the key **open**.
The parameter settings of the last run are displayed.

5.4.2 Inserting the rotor



Warning! Risk of injury from chemically or mechanically damaged accessories.

Even minor scratches and cracks can result in serious internal material damage.

- ▶ Protect all parts from mechanical damage.
- ▶ Check accessories regularly.
- ▶ Do not use rotors, rotor lids or buckets with signs of corrosion or mechanical damage (e.g. deformations).
- ▶ Do not use accessories whose maximum useful life has been exceeded.
- ▶ When inserting the buckets in the swing-bucket rotor, ensure that they do not become scratched.



Rotor A-2-MTP: before inserting or removing the rotor, remove the buckets and grip the rotor by the rotor cross with both hands (see p. 38).

Rotor F-35-6-30: Only use the rotor removal tool supplied to insert or remove the rotor (see p. 37).

1. Place rotor vertically onto the motor shaft.
2. Insert the rotor key supplied into the rotor nut.
Rotor FA-45-24-11-HS: Use the special rotor key.
3. Turn rotor key **clockwise** until the rotor nut is firmly tightened.

5.4.3 Automatic rotor detection

The centrifuge has automatic rotor detection. It detects a newly inserted rotor during centrifugation and displays its name for approx. 2 sec. The set g-force (rcf)/speed is automatically limited to the maximum limited value of the rotor, if necessary.



If you start centrifuging immediately after a rotor change, then the centrifuge has not yet carried out an automatic rotor detection. The speed set for the previous rotor may exceed the maximum permitted speed for the new rotor. In this case the centrifuge stops after the automatic rotor detection and displays the error message **Note C**. The new maximum permitted speed appears in the display. You can then restart the centrifuging with this setting or adjust the speed.

- ▶ Always check the set g-force/speed after a rotor change and adjust it if necessary.

5.4.4 Manual rotor detection

Caution! Risk of injury when turning the rotor manually.

- ▶ Note especially for the rotor A-2-MTP that you do not squeeze your fingers or get caught at the swing buckets.

5 Operation

- ▶ To trigger the rotor detection manually before centrifuging with a new rotor, turn the rotor by hand **counterclockwise**.
 - The name of the rotor appears in the display.
 - The set g-force (rcf)/speed is automatically limited to the maximum limited value of the rotor, if necessary.

5.4.5 Load fixed-angle rotor

The following notes apply to fixed-angle rotors. The loading of swing-bucket rotors is described in the following chapter (see *Load swing-bucket rotor* on page 30).



Warning! Risk of injury from unsymmetric loading of rotors.

- ▶ Load rotors symmetrically with identical tubes and/or buckets and plates.
- ▶ Only load adapters with suitable tubes and/or plates.
- ▶ Always use tubes and/or plates of the same type (weight, material/density and volume).
- ▶ Check for symmetric loading by ensuring the adapters and tubes and/or plates used are even with scales.

The device automatically detects imbalances during operation and stops centrifugation immediately with an error message and a signal tone. Check the loading, balance the tubes and restart the centrifugation.



Warning! Risk from damaged or overloaded tubes!

- ▶ When loading the rotor note the safety instructions with regard to hazards from overloaded or damaged tubes (see *Warnings for intended use* on page 17)



Rotor lid!

- Fixed-angle rotors may only be operated with the appropriate rotor lid in each case. This is clearly shown by the identical rotor name labeling on the rotor and on the rotor lid.
- To carry out an aerosol-tight centrifuging an aerosol-tight rotor (marking: **red ring**) and corresponding aerosol-tight rotor lid (marking: **aerosol-tight** and **red lid screw**) must be used.

To load the rotor, proceed as follows:

1. Check the maximum load (adapter, tube and content) per rotor bore.
The information about this can be found on every rotor and in this operating manual (see *Rotors* on page 13).
2. Load rotors and adapters only with the tubes intended for them.
3. Insert tubes opposite each other in pairs into the rotor bores. For symmetrical loading, tubes that are opposite each other must be of the same type and contain the same filling quantity.

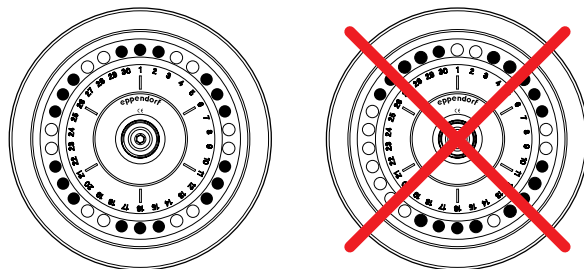

In order to minimize weight differences between filled sample tubes, we recommend taring with a scale. This will reduce wear on the drive and cut running noise.

4. Attach and tighten rotor lid.

5 Operation



Spin Columns

For centrifuging Spin Columns in the rotor FA-45-24-11-Kit you can leave the tube lids open. However, this is possible only using the tubes provided for this purpose by kit manufacturers. For reliable centrifugation, you must lean the open tube lids against the edge of the rotor. Ensure that this does not involve the lids projecting vertically beyond the edge of the rotor, and then put on the associated rotor lid.

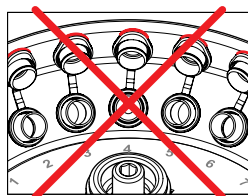
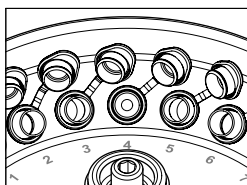

5.4.6 Load swing-bucket rotor

Requirement

- A combination of rotor, bucket and adapter, approved by Eppendorf.
- **Two** inserted buckets.
- Opposing buckets belong to the same weight category. It is stamped onto the side of the groove, e.g. 68 (the last 2 digits in grams).
- Matching and tested tubes and plates.
- Adapters and plates with a total height of ≤ 29 mm.

Caution! Filling the plates too high can cause overflowing.

During centrifugation the menisci in the tubes along the edges of the plates are at an angle. This is due to the centrifugal forces and cannot be avoided.

- ▶ Fill the wells of the plates to a maximum of 2/3 of the max. capacity.



Warning! Risk of injury from unsymmetric loading of rotors.

- ▶ Load rotors symmetrically with identical tubes and/or buckets and plates.
- ▶ Only load adapters with suitable tubes and/or plates.
- ▶ Always use tubes and/or plates of the same type (weight, material/density and volume).
- ▶ Check for symmetric loading by ensuring the adapters and tubes and/or plates used are even with scales.

The device automatically detects imbalances during operation and stops centrifugation immediately with an error message and a signal tone. Check the loading, balance the tubes and restart the centrifugation.

To load the rotor, proceed as follows:

1. Check the bucket grooves for cleanliness and grease lightly with pivot grease (order no. Int.: 5810 350.050 / North America: 022634330).
Dirty grooves and pivots prevent buckets from swinging out evenly.
2. Hang the buckets into the rotor.
3. Check that both buckets are hanging properly and can swing freely.
4. When using a plate type for the first time, carry out a manual loading and settling test.
5. Check maximum load (adapter, plate and content) per bucket.

The relevant details can be found on the rotor and in this operating manual (see *Rotors* on page 13).

5 Operation

EN

6. Load the buckets symmetrically.

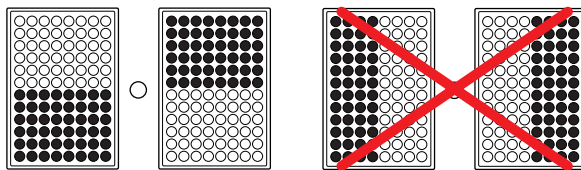

Fig. 5: Symmetrical loading of the plates.

The plate arrangement shown on the right-hand side is incorrect, as the bucket will not swing properly.

The plates have some play in the buckets.

7. Attach and tighten the wind shield upper shell.



Only 5430 R: When using a swing-bucket rotor, centrifuge without wind shield upper shell to ensure the precise temperature control of the samples. Note that the centrifugation noise will increase slightly in this case.

5.4.7 Close centrifuge lid



Warning! Centrifuge lid can crush. Keep hands clear.

- ▶ When opening or closing the device lid, do not reach between the device and lid or into the latching mechanism of the lid.
- ▶ Always open the centrifuge lid completely to prevent it from falling closed.

1. Check correct attachment of rotor and rotor lid.
2. Push down the centrifuge lid until the lid latch engages and the lid is automatically closed. The centrifuge will close automatically.

The **open** key lights blue. The display shows the symbol .

5 Operation

5.5 Cooling (only 5430 R)

5.5.1 Temperature adjustment

- ▶ Set the temperature using the arrow keys **temp** between -11 °C and +40 °C. You can also modify the temperature during centrifugation.

5.5.2 Temperature display

If the rotor is stopped: Target temperature
 During centrifugation: Actual temperature

The extended display always displays the target temperature at the bottom.

5.5.3 Temperature monitoring

After the target temperature has been reached the centrifuge responds as follows to temperature deviations during centrifugation:

Deviation from the target value	Action
$\Delta T > 3 \text{ °C}$	Temperature display flashes.
$\Delta T > 5 \text{ °C}$	Periodic warning tone and display Error 18 . Centrifugation is stopped automatically.

5.5.4 Fast Temp

With this function you start a temperature control run directly without samples with a rotor and temperature-specific speed in order to bring the rotor chamber incl. rotor, buckets and adapters quickly up to the set target temperature.

The **Fast Temp pro** function for programming the temperature control run with defined start times is described in the next section.

Requirement

- Centrifuge is switched on.
- Rotor and rotor lid are properly attached.
- The centrifuge lid is closed.

1. Press the **fast temp** key.

The display shows **Fast Temp**, the remaining duration of the temperature control run and the actual temperature and g-force (rcf)/speed.

The temperature control run ends automatically when the target temperature has been reached. A periodic signal tone sounds.

2. Press the **start/stop** key to terminate the temperature control run early.

After the target temperature has been reached and the temperature control run is complete, the centrifuge keeps the rotor chamber with the centrifuge lid closed at the set target temperature if the temperature is below the ambient temperature. Irrespective of the target temperature, however, this continuous cooling does not go below 4 °C to prevent the rotor chamber from freezing.



The centrifuge stops the run automatically if the rotor or the buckets have reached the set temperature. Therefore, there may be a delay between the display of the achieved target temperature and the automatic end of the temperature control run.



When using a swing-bucket rotor, centrifuge without a wind shield upper shell to ensure precise and rapid temperature control of the samples. Note that the centrifugation noise will increase slightly in this case.

5 Operation

5.5.5 Fast Temp pro

You can have the previously described temperature control run **Fast Temp** (see p. 32) start automatically at specified times. Two options are available:

Once	The temperature control run is started once at the set time.
Repeatedly	The temperature control run is started at the set time on the next specified weekday. This is repeated for an unlimited period of time with each weekday specified.

Programming the start time

1. Select **Fast Temp pro** in the device menu (see the menu structure on the rear fold-out page).
2. Select **Once** or **Repeatedly**.
This selection only appears as long as the **Fast Temp pro** function has not already been activated. Otherwise it is only possible to edit or delete the programmed start time.
3. Only with **Repeatedly**: Activate/deactivate weekdays with **menu/enter**, select **Continue** and confirm with **menu/enter**.
4. Enter the date and time for the temperature control run start "Once" or "Repeatedly" as well as the target temperature and confirm with **menu/enter**.
An overview of the current settings is displayed.
5. Edit the settings again or save.
6. Exit the menu.
 - **Fast Temp pro** is now activated. In the display the symbol **fTpro** appears as long as an automatic start of a temperature control run is still outstanding. In the standby mode **fTpro** **Fast Temp pro** is displayed.
 - The temperature control run **Fast Temp** (see p. 32) starts automatically at the set time.
 - After a one-off programmed temperature control run, the following symbol is extinguished (**fTpro**). With several programmed temperature control runs, the **Fast Temp pro** function remains active until you deactivate it. To do this, select **Fast Temp pro** in the device menu and delete the settings.

Preparing the centrifuge

- ▶ Ensure that the centrifuge is switched on or in the standby mode during the start time set and the rotor and rotor lid are properly attached and the centrifuge lid is closed.
- ▶ Ensure that the rotor inserted has been detected by the centrifuge (see *Automatic rotor detection* on page 28). Otherwise, if the centrifuge detects a rotor with a lower g-force (rcf)/speed than set when starting the temperature control run, it will display an error message and not start the temperature control run.

Automatic start of the temperature control run

1. If the centrifuge is in standby mode, it switches to the operating mode 1 min before the set start time.
2. At the start time the temperature control run **Fast Temp** (see *Fast Temp* on page 32) begins. The display shows **Fast Temp pro**.

Automatically starting the temperature control run is not possible during centrifugation.

5 Operation

5.5.6 Continuous cooling

When the rotor is stopped the rotor chamber is kept at the target temperature until the following prerequisites are met:

- The centrifuge is switched on.
- The centrifuge lid is closed.
- The target temperature is below the ambient temperature.
- The centrifuge is not in standby mode.

During continuous cooling the following applies:

- The target temperature is displayed.
- Irrespective of the target temperature, continuous cooling does not go below 4 °C to prevent the rotor chamber from freezing and increased condensation in the device.
- Because the rotor does not rotate during this process the temperature adjustment is slower.

To end continuous cooling, open the centrifuge lid or press the standby key.

If the centrifuge is not used for more than 8 hours, the continuous cooling is switched off automatically. The device then switches to standby mode. This protects against ice formation in the rotor chamber and increased condensation in the device. The display shows **ep**. With **Fast Temp** you can quickly reach the desired temperature again (see p. 32).

You can change the continuous cooling to endless operation at your own risk. To do so, enable in the device menu under **Continuous cooling** the item ∞ (see p. 40).

5.6 Centrifuging



Warning! Risk from incorrectly-loaded rotors and damaged/overloaded tubes!

- ▶ Before commencing centrifugation follow the safety instructions relating to hazards from unsymmetrically loaded and/or overloaded rotors and from overloaded, damaged and/or open tubes (see *Warnings for intended use* on page 17).



Warning! Risk of injury from improperly attached rotors and rotor lids.

- ▶ Centrifuge only with the rotor and rotor lid firmly tightened.
- ▶ If unusual noises occur when the centrifuge starts, the rotor or the rotor lid may not be properly secured. Stop centrifugation immediately by pressing the **start/stop** key.



The following sections describe the operation of the centrifuge using the keypad. In the device version with dials the run time and g-force (rcf)/speed are set by the dials instead of the arrow keys.

Each of the centrifuging variants described here must be preceded by the preparation described above. (see *Preparing for centrifugation* on page 28).

Only 5430 R: Please also note the instructions on cooling (see *Cooling (only 5430 R)* on page 32).



5 Operation

5.6.1 Centrifuging with time preset

Perform the following steps in the sequence described.

1. Use the **time** arrow keys to set the run time.
2. **Only 5430 R:** Use the **temp** arrow keys to set the temperature.
3. Use the **speed** arrow keys to set the g-force (rcf)/speed.
4. Press **start/stop** to start centrifuging.

During centrifugation

- In the display  flashes while the rotor is running.
- The remaining run time is displayed in minutes. The last minute is counted down in seconds.
- **Only 5430 R:** The actual temperature is displayed.
- The current g-force (rcf) or rotor speed is displayed.
- The shortcut keys, the keys , **open** and **short** and all menu items directly affecting the centrifugation are blocked during centrifugation.

End of centrifugation



- After expiry of the set time, the centrifuge stops automatically. During braking the elapsed centrifugation time is displayed flashing. If the rotor stops a signal tone is sounded.
 - **Only 5430:** The centrifuge lid opens automatically. The display shows the symbol .
 - **Only 5430 R:** The centrifuge lid remains closed to maintain the sample temperature. You can open it by pressing the flashing key **open**.
5. Remove centrifuge content.



- During the run you can modify the total run time, the temperature (only 5430 R), the speed and the rpm/rcf indication. The new parameters are adopted immediately. Note that the shortest new total run time which can be set is the time which has already elapsed plus 2 minutes.
 - You can also terminate the centrifugation before the set run time by pressing the key **start/stop** key.
-

5.6.2 Centrifuging in continuous operation



Perform the following steps in the sequence described.

1. With the arrow keys **time** set continuous operation.
The continuous operation function can be set above 99:59 h or below 30 seconds. The timer shows  to indicate continuous operation.
2. **Only 5430 R:** Use the **temp** arrow keys to set the temperature.
3. Use the **speed** arrow keys to set the g-force (rcf)/speed.
4. Press **start/stop** to start centrifuging.
In the display  flashes while the rotor is running.
Time is counted upwards, first in 30-second increments and then in minute increments from ten minutes.
5. Press **start/stop** to end centrifuging after the desired time period.
 - During the braking process, centrifuging duration flashes in the display.
 - If the rotor stops a signal tone is sounded.
 - **Only 5430:** The centrifuge lid opens automatically. The display shows the symbol .
 - **Only 5430 R:** The centrifuge lid remains closed to maintain the sample temperature. You can open it by pressing the flashing key **open**.
6. Remove centrifuge content.

5 Operation

5.6.3 Short Spin centrifugation

You can carry out a short-spin run with the currently set or with the maximum g-force (rcf)/speed of the rotor used. This is set in the device menu (see *Other menu items* on page 40) before executing the following steps in the sequence specified:

1. For short-spin run with the current g-force (rcf)/speed, set this directly with the arrow keys **speed**.
2. **Only 5430 R:** Use the **temp** arrow keys to set the temperature.
3. Start short-spin run: Hold down the **short** key.
 - In the display  flashes while the rotor is running.
 - The time is counted upwards in seconds.
 - During short run centrifuging all other keys are blocked. However, short run centrifuging is interrupted if another key is pressed simultaneously.
4. End short-spin run: Release the **short** key.
 - During the braking process, centrifuging duration flashes in the display.
 - If the rotor stops a signal tone is sounded.
 - **Only 5430:** The centrifuge lid opens automatically. The display shows the symbol .
 - **Only 5430 R:** The centrifuge lid remains closed to maintain the sample temperature. You can open it by pressing the flashing key **open**.
5. Remove centrifuge content.



During the braking process, centrifuging can be restarted up to two times by pressing the **short** key again.



Soft ramp is not used for Short Spin centrifuging.

5.6.4 Remove rotor



Rotor A-2-MTP: before inserting or removing the rotor, remove the buckets and grip the rotor by the rotor cross with both hands (see p. 38).

Rotor F-35-6-30: Only use the rotor removal tool supplied to insert or remove the rotor (see p. 37).

-
1. Turn rotor nut **counterclockwise** using the rotor key supplied.
Rotor FA-45-24-11-HS: use the special rotor key.
 2. Remove rotor by lifting vertically.
 3. **Only 5430 R:** Switch off the centrifuge after use and empty the tray for condensation water (pull out from the left side of the device). Leave centrifuge lid fully opened and protect it against closing.

5 Operation

5.7 Standby mode

The centrifuge automatically changes from the ready state to the standby mode if the following prerequisites are met:

- The centrifuge was not used for the time set in the device menu (1 to 60 min) (see *Settings* on page 41).
- **Only 5430 R:** The centrifuge lid is open.

In **standby mode** the following applies:

- The display shows **ep**.
- The standby key  lights red.
- **Only 5430 R:** The rotor chamber is not cooled (see *Continuous cooling* on page 34).

In **ready state** the following applies:

- The centrifugation parameters are displayed.
- The standby key  lights green.
- **Only 5430 R:** The rotor chamber is cooled when the centrifuge lid is closed (see *Continuous cooling* on page 34).

You can switch between standby mode and ready state at any time when centrifugation is not performed by pressing the standby key.

5.8 Usage notes for rotors

5.8.1 Rotor F-35-6-30: Rotor removal tool

Transferring rotor

Requirement

The rotor nut has been unscrewed.

Use the rotor removal tool to reinsert the rotor into the centrifuge and to remove it again.

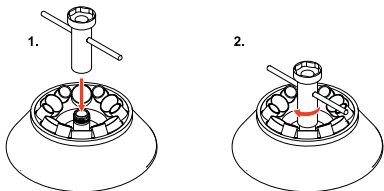

1. Mount the rotor removal tool with the narrow side onto the rotor thread.
2. Tighten the rotor removal tool with approx. 3 clockwise turns.
3. Grip the rotor removal tool and transfer the rotor.
4. Undo the rotor removal tool by turning it counterclockwise and remove.
5. **Insert rotor:** Tighten rotor with rotor key supplied (see *Inserting the rotor* on page 28).

Unscrew rotor lid

Use the rotor removal tool to undo a tightened rotor lid screw.

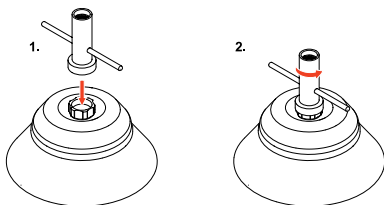

1. Place the rotor removal tool with the broad side onto the rotor lid screw.
2. Undo the rotor lid screw aid by turning the rotor removal tool counterclockwise.

5 Operation

5.8.2 Rotor A-2-MTP

Transferring the rotor

Caution! If handled incorrectly, the rotor can fall over.

The rotor buckets A-2-MTP must not be used as a handle.

- ▶ Before moving the rotor, remove the buckets.
- ▶ Always pick up the rotor at the rotor cross, using both hands.

Attaching and lifting off the wind shield upper shell

The wind shield upper shell is designed to reduce noise.

1. Prior to first use, remove the tag fixed to the knob of the wind shield upper shell.
2. Attach the wind shield upper shell and turn by max. 1/4 turn until it lowers onto the rotor hub.
The lock indicator must jut out of the knob to the extent that its red marking is visible:

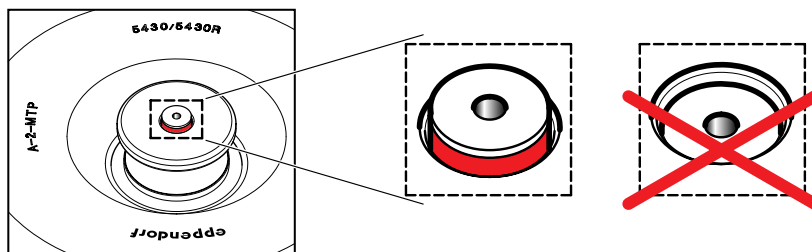

The upper shell is designed to sit loosely. This is necessary for self-alignment purposes.

3. Pull the knob of the wind shield upper shell to lift it off.



Only 5430 R: When using a swing-bucket rotor, centrifuge without a wind shield upper shell to ensure precise and rapid temperature control of the samples. Note that the centrifugation noise will increase slightly in this case.

5.8.3 Rotor FA-45-24-11-HS: Use the special rotor key

Tighten rotor

1. Insert rotor key for rotor FA-45-24-11-HS into the rotor nut.
2. Turn rotor key clockwise until it slips ('click sound').
The rotor has been tightened correctly.

Unscrew rotor

- ▶ Turn rotor nut counterclockwise using the rotor key for rotor FA-45-24-11-HS.



The rotor key for rotor FA-45-24-11-HS can only be used to tighten and unscrew this rotor. For the other rotors described in this operating manual use the rotor key supplied with the Centrifuge 5430 / 5430 R .

6 Operating controls and function

6.1 Device menu

A depiction of the menu structure of the Centrifuge 5430 / 5430 R can be found on the rear fold-out page (see Table on page 390). Most menu levels contain the additional menu item **Back / Zurück / Retour / Atrás**. Detailed information can be found in the following chapters.

6.2 Settings in the device menu

6.2.1 Programs

The Centrifuge 5430 / 5430 R has more than 50 programmable memory locations.

Load program	Load the selected program. This appears in the display with number and name and can be started immediately using the <->start/stop key. When selecting a program with a too high g-force (rcf)/speed for the rotor used, it flashes and a safety message appears.
Save program	Save the set centrifugation parameters (centrifugation duration, temperature (only 5430 R), g-force (rcf)/speed, soft ramp and At set rpm) under the selected number. In addition, you can assign a program name with a maximum of 20 characters. The centrifuging duration, the temperature (only 5430 R) and the g-force/rotational speed can still be changed in this menu using the corresponding arrow buttons time , temp (only 5430 R) and speed .
Delete program	Delete the selected program. Program numbers 1 to 5 cannot be deleted.

These functions are only available with the centrifuge at a standstill.

If the program memory is empty the menu item **Delete program** is exited automatically after the last program has been deleted. You will furthermore be unable to call up this menu item if the program memory is empty.

Program numbers which are already occupied can be overwritten.

6.2.2 Use program keys

You can also save and load Programs 1 to 5 directly by pressing the program keys:

Load program

- ▶ Press the desired program key **briefly**.

The pressed program key illuminates in blue, the parameters are displayed.

By pressing again, you can exit the selected program again. The blue light of the key will then go out. The parameters of the most recent centrifugation are then displayed again.

Save program







1. Set the centrifugation parameters (centrifugation duration, temperature (only 5430 R), g-force (rcf)/speed, soft ramp and At set rpm).
2. Press the desired program key for at least **2 seconds**.

A signal tone sounds and the program key you pressed lights up.

The centrifuging parameters are saved under the appropriate program number (1-5).







6 Operating controls and function

6.2.3 Other menu items

Menu item/meaning	Setting	Function	Display
Soft ramp Reduce speed of acceleration and braking ramp. Not used for Short Spin centrifuging.	on	Rotor accelerates and brakes slowly.	
	off	Rotor accelerates and brakes rapidly.	
Key lock Set the current centrifugation parameters permanently to prevent the time, temperature (only 5430 R), g-force (rcf) or speed, soft ramp and At set rpm from being unintentionally modified.	on	Set the centrifugation parameters permanently.	
	off	Release the permanent settings.	
At set rpm Set start of centrifuging run time.	on	The set time is counted down only once 95% of the specified g-force (rcf) or speed has been reached.	
	off	The set time is counted down immediately.	
Short Spin Before the start of a short run (see <i>Short Spin centrifugation</i> on page 36) it is possible to switch between the maximum and currently set g-force (rcf) or speed. Soft ramp is not used for Short Spin centrifuging.	Maximum value	Short-spin run at maximum g-force (rcf) or speed of the rotor used.	
	Current value	Short run at set g-force (rcf)/speed.	
Continuous cooling (only 5430 R) Time limitation of continuous cooling (see p. 34) . Continuous cooling is only activated when the rotor is stopped and the centrifuge lid is closed.	8 h	Preset value.	
	∞	Endless operation of continuous cooling. Caution! Icing possible! Set at own risk!	
Fast Temp pro (only 5430 R) Time and temperature programming for the automatic temperature control run. The selection Once/Repeatedly only appears if no Fast Temp pro has been set (see <i>Fast Temp pro</i> on page 33).	Once	Set the date and time for the start of a temperature control run.	
	Repeatedly	Set the week days and the common start time for several repeated temperature control runs. Fast Temp pro is active from the date set.	

6 Operating controls and function

6.2.4 Settings

Menu item/meaning	Setting	Function	Display
Display Select standard display or extended display of centrifuging parameters.	Standard display Extended display	If the centrifuge is at rest the target values are displayed, and during centrifugation the actual values of run time, temperature (only 5430 R) and the g-force (rcf)/speed. In addition to the standard display, specified values are always shown at the bottom of the display.	
Loudspeaker Switch loudspeaker on and off. In the event of error messages, a signal tone sounds even if the loudspeaker is switched off.	On Off	Switch on loudspeaker. Switch off loudspeaker.	 
Volume Adjust the speaker volume using the menu arrow keys  and  in 5 stages. The signal tone for error messages is always issued at least at medium volume.	Cancel Save Default	Exit menu item without saving. Save volume just set. Restore default volume.	
Date/time Set date and time. The system does not switch automatically between summer and winter time.		In the date display, set year (YYYY), month (MM) and day (DD). In the time display, set hours (hh) and minutes (mm). Before setting the clock time the time format is selected (12 h / 24 h).	
Contrast Adjust the display contrast using the menu arrow keys  and  .	Cancel Save Default	Exit menu item without saving. Save the contrast just set. Restore default contrast.	
Language		Set menu language (English, Deutsch, Français or Español) . (see <i>Set menu language</i> on page 26).	
Standby Switch standby mode on and off. If the centrifuge is not used during the set time period and no continuous cooling takes place (only 5430 R), it switches to the standby mode (see p. 37).	On Off Set time	Switch on standby mode. Switch off standby mode. Using the arrow keys, set the time after which the centrifuge should automatically change to the standby mode (1 to 60 min).	
Lid release (only 5430)	Automatic Manual	Lid opens automatically at the end of centrifuging when the rotor stops. Lid remains closed at the end of centrifuging when the rotor stops and can be opened using the now flashing key open .	

7 Maintenance

7.1 Prepare cleaning / disinfection

Clean at least once a month and clean if the accessible surfaces of the device and its accessories are acutely contaminated.

Clean the rotor regularly. This way the rotor is protected and the durability is prolonged.

Pay attention to the additional notes regarding decontamination (see *Decontamination before shipping* on page 45), if you send the device to the authorized technical service for repair.

The procedure described in the following chapter applies for the cleaning as well as for the disinfection or decontamination. In the following table the additional necessary steps are described:

Cleaning	Disinfecting / decontamination
<ol style="list-style-type: none"> For cleaning the accessible surfaces of the device and the accessories use a mild cleaning fluid. Carry out the cleaning as described in the following chapter. 	<ol style="list-style-type: none"> Choose the disinfection method which corresponds to the legal determinations and guidelines in place for you range of application. Use e.g. alcohol (ethanol, isopropanol) or alcohol-based disinfectants. Carry out the disinfection or decontamination as described in the following chapter. Then clean the device and the accessories.



If you have any further questions regarding the cleaning and disinfection or decontamination as well as regarding the cleaning fluid to be used contact the Eppendorf AG Application Support. The contact details are given on the back of this manual.

7.2 Perform cleaning/disinfecting



Danger! Electric shock as a result of penetration of liquid.

- ▶ Switch off the device and disconnect it from the power supply before starting cleaning or disinfecting.
- ▶ Do not allow any liquids to enter the inside of the housing.
- ▶ Do not perform spray disinfection.
- ▶ Only reconnect the device to the power supply once it is completely dry.

Caution when using aggressive chemicals.

Aggressive chemicals may damage both the device and its accessories.

- ▶ Do not use any aggressive chemicals on the device and accessories such as strong or weak bases, strong acids, acetone, formaldehyde, halogenated hydrocarbons or phenol.
- ▶ If the device becomes contaminated with aggressive chemicals, clean it immediately with a neutral cleaning agent.

Caution! Corrosion from aggressive cleaning agents and disinfectants.

- ▶ Do not use corrosive cleaning agents, aggressive solvents or abrasive polishes.
- ▶ Do not incubate the accessories in aggressive cleaning agents or disinfectants for prolonged periods.

Caution! Material damage from UV and other high-energy radiation.

- ▶ Do not use UV, beta, or gamma radiation or any other high-energy radiation source for disinfecting.

7 Maintenance



Autoclave

All rotors, rotor lid, buckets and adapters with the exception of rotor A-2-MTP can be autoclaved (121 °C, 20 min).

After a maximum of 10 autoclave cycles, replace the lids of the aerosol-tight rotors.



Aerosol-tightness

Check that the seals are intact before use.

Replace the rotor lids of aerosol-tight rotors when the sealing rings on the lid screw and in the lid groove are worn. The sealing rings require regular care to protect the rotors.

Never store aerosol-tight rotors with rotor lids screwed on tightly!

Regularly grease the lid thread of the aerosol-tight rotors lightly with pivot grease to prevent damage (order no. Int.: 5810 350.050 / North America: 022634330).



Swing-bucket rotors

- Before cleaning the rotor, remove old pivot grease from grooves and pivots.
- Make sure that the grooves and pegs are clean. Dirty grooves and pivots prevent buckets from swinging out evenly.
- Lightly grease the rotor pivots and the bucket grooves with pivot grease after cleaning (order no. Int.: 5810 350.050 / North America: 022634330), so that the bucket can move freely in a swinging manner.

Perform the following steps in the sequence described.

1. Switch off the device with open lid from the mains power switch and remove the mains power switch from the power supply.
2. Undo the rotor nut by turning it counterclockwise with the rotor key.
3. Remove rotor. The cleaning procedure for the rotor is described below.
4. To clean and disinfect the device and the rotor chamber use the agents specified above (see p. 42).
5. Wipe all accessible surfaces of the device and the accessories including the power cable with moist cloth.
6. Thoroughly wash the rubber seals at the housing with water.
7. Rub the dry rubber seals with glycerine or talcum powder to prevent them from becoming brittle. Other components of the device, such as the lid latch and the lid springs must not be lubricated.
8. rotors, rotor lid, buckets and adapters clean with the aforementioned agents and disinfect (see p. 42).
9. To clean and disinfect the tube bores of the fixed angle rotors use a bottle brush.
10. Rinse rotors, rotor lid, buckets and adapters thoroughly with water. Pay particular attention to the tube bores of the fixed angle rotors.
11. Place rotors and accessories onto a cloth to dry. Place fixed angle rotors with the tube bores facing downwards to allow the bores also to dry.
12. Check device and accessories for corrosion and damage.
13. Clean motor shaft and rotor cone with a soft, dry and lint-free cloth and look out for damage.
14. Place the dry rotor onto the motor shaft.
15. Tighten the rotor nut firmly by turning it clockwise with the rotor key.
16. Load the fixed angle rotor with the cleaned adapters or the swing-bucket rotor with the cleaned buckets and adapters, if necessary.

7 Maintenance

7.3 Additional service instructions for Centrifuge 5430 R

- ▶ Empty and clean the tray for condensation water regularly and especially after liquid spillage in the rotor chamber. Pull out the tray for condensation water from the left side of the centrifuge.
- ▶ Also regularly clean the condensate drainage channels, e.g., using a bottle brush.
- ▶ Clear the rotor chamber regularly of ice formations by thawing, either by leaving the centrifuge lid open or carrying out a brief temperature control run at approx. 30 °C.
- ▶ Wipe up condensate in the rotor chamber. To do so, use a soft absorbent cloth.
- ▶ Remove dust deposits from the ventilation slits of the centrifuge using a brush or swab at the latest every six months. First switch off the device and remove the power plug.
- ▶ Never block the vents of the centrifuge!
At higher ambient temperature a brief fan noise is possible until the desired temperature has been reached. This indicates a heavy cooling performance.
- ▶ Regularly check the gas spring of the centrifuge lid for proper functioning.
A defective gas spring is an insufficient support for the centrifuge lid and could cause injury if the centrifuge lid falls down. We recommend that the gas spring be replaced by a service technician every 2 years.

7.4 Glass breakage



Note that, when using the glass tubes, the danger of breakage of glass increases with an increasing g number (rcf)/rotational speed. Please note the manufacturer's information on the recommended centrifugation parameters (loading and speed).

Glass splinters scratch the surfaces of the rotor chambers and the accessories (rotors, rotor lid, buckets and adapters), with the effect that its resistance to chemicals is reduced. Therefore a fine and black metal abrasion develops in the rotor chamber due to the air turbulence which apart from causing damage to the rotor chamber and the accessories also contaminates the samples.

- ▶ Carefully remove all splinters and glass powder from the rotor chamber and accessories when breakage of glass occurs (rotors, rotor lid, buckets and adapters).
- ▶ If required, replace rubber mats and adapters to prevent any further damage.
- ▶ Check rotor bores regularly for residues or damage.

7.5 Fuses

7.5.1 Centrifuge 5430

The fuse holder is located beneath the mains power socket (see Fig. 1).

1. Disconnect the mains plug.
2. Pull the fuse holder out backwards.
Both fuses are now accessible and can be replaced.

7.5.2 Centrifuge 5430 R

Centrifuge 5430 R does not have any removable fuses but a thermal overcurrent protection switch. If it is triggered the mains power switch jumps into the switch position '0'.

1. Switch the device back on after > 20 sec by pressing the mains power switch.
2. If the mains power switch jumps back into the switch position '0' contact the Technical Service.

7 Maintenance

7.6 Decontamination before shipping

If you are shipping the device to the authorized Technical Service for repairs or to your authorized dealer for disposal please note the following:



Warning! Risk to health from contaminated device

1. Follow the instructions in the decontamination certificate. It is available in PDF format on our homepage. (www.eppendorf.com/decontamination).
 2. Decontaminate all the parts you want to dispatch.
 3. Enclose the fully-completed decontamination certificate for returned goods (incl. the serial number of the device) with the dispatch.
-

8 Troubleshooting

If the suggested measures fail repeatedly, please contact Technical Service. You can find the contact addresses at the end of this operating manual or on the Internet under www.eppendorf.com (International) or www.eppendorfna.com (North America).

8.1 General errors

Symptom / message	Cause	Remedy
No display.	No mains connection.	▶ Check mains power connection.
No display.	Power failure.	▶ Check mains fuse for the centrifuge (see <i>Fuses</i> on page 44). ▶ Check mains fuse of the laboratory.
Lid of the device cannot be opened.	Rotor still running.	▶ Wait for rotor to stop.
Lid of the device cannot be opened.	Power failure.	1. Check mains fuse for the centrifuge (see <i>Fuses</i> on page 44) . 2. Check mains fuse for the laboratory. 3. Activate emergency lid release (see p. 48).
Device cannot be started.	Lid of the device not closed.	▶ Close lid of the device.
Device shakes when it starts up.	Rotor unsymmetrically loaded.	1. Stop device and load symmetrically. 2. Restart device.
Centrifuge brakes during a short run centrifugation, although the short key was pressed.	short key was released briefly more than twice (protective function for the drive).	▶ Press the short key continuously during a short-run centrifugation.

8.2 Error messages

If one of the following error messages appears proceed as follows:

1. Remove fault (see Remedies).
2. Press **open** to clear the error message.
3. If necessary, repeat centrifuging.

Some errors can have various causes. The actual cause is described by the message in the device display.

Symptom / message	Cause	Remedy
Error 1 Rotor detection	Rotor not detected.	▶ Check rotor. ▶ If this error message appears again, test with a different rotor.
Error 2 Electronics fault	Electronics fault.	▶ Switch centrifuge off and back on again after > 20 s.
Error 3 Speed check	Error in speed measuring system.	▶ Insert and tighten rotor.
Error 3 Speed check	Error in speed measuring system.	▶ Wait for displayed time.
Error 5 Lid latch	Prohibited opening of lid or lid switch defective during a run.	▶ Wait for rotor to stop.

8 Troubleshooting

Symptom / message	Cause	Remedy
Error 6 Drive fault	Drive fault.	▶ Switch centrifuge off and back on again after > 20 s.
Error 6 Drive fault	Drive fault	▶ Repeat run.
Error 6 Drive fault	Drive overheated.	▶ Allow drive to cool down for at least 15 min.
Error 7 Speed check	Major deviation in the speed check.	1. Wait for rotor to stop. 2. Tighten rotor.
Error 8 Speed check	<ul style="list-style-type: none"> • Rotor loose. • Drive fault. • Incorrect rotor. 	1. Wait for rotor to stop. 2. Tighten rotor.
Error 9 to Error 14 Electronics fault	Electronics fault.	▶ Switch centrifuge off and back on again after > 20 s.
Error 15 Imbalance	Rotor unsymmetrically loaded.	▶ Load rotor symmetrically, check load even.
Error 16 to Error 17 Electronics fault	Electronics fault.	▶ Switch centrifuge off and back on again after > 20 s.
Error 18 Room temp. of rotor chamber (only 5430 R)	Temperature deviation from the target value in the rotor chamber: $\Delta T > 5 \text{ }^\circ\text{C}$.	▶ Check the settings and repeat run.
Error 18 Room temp. of rotor chamber (only 5430 R)	Temperature deviation from the target value in the rotor chamber: $\Delta T > 16 \text{ }^\circ\text{C}$.	▶ Allow device to cool down and repeat run.
Error 18 Room temp. of rotor chamber (only 5430 R)	Temperature deviation from the target value in the rotor chamber: $T > 50 \text{ }^\circ\text{C}$.	▶ Allow device to cool down and repeat run.
Error 19 Condenser temperature (only 5430 R)	Condenser overheated.	▶ Check unhindered air circulation through vents and allow device to cool down.
Error 20 Room temp. of rotor chamber (only 5430 R)	Temperature sensor in rotor chamber faulty.	▶ Switch centrifuge off and back on again after > 20 s.
Error 21 Condenser temperature (only 5430 R)	Temperature sensor at condenser faulty.	▶ Switch centrifuge off and back on again after > 20 s.
Error 22 Electronics fault (only 5430 R)	Electronics fault.	▶ Switch centrifuge off and back on again after > 20 s.
Error 24 Compressor (only 5430 R)	Electronics fault at the compressor.	▶ Repeat run.

8 Troubleshooting

Symptom / message	Cause	Remedy
Error 24 Compressor (only 5430 R)	Cooling unit could not start.	▶ Allow centrifuge to cool down and repeat run.
Error 25 Mains power failure	Mains power failure during a run.	▶ Check power supply.
Error 26 Electronics fault (only 5430 R)	Electronics fault.	▶ Switch centrifuge off and back on again after > 20 s.
Error 27 Electronics fault (only 5430 R)	Electronics fault.	▶ Switch centrifuge off and back on again after > 20 s.
Error 28 Electronics fault	Electronics fault.	▶ Press the open key.
Error 29 Rotor detection	Set rcf/speed too high, e.g. after rotor change (see <i>Automatic rotor detection</i> on page 28).	1. Check rcf/speed. 2. Repeat run.
Error 30 Lid latch	Centrifuge lid could not be latched.	▶ Try again to close centrifuge lid.
Error 30 Lid latch	Centrifuge lid could not be unlatched.	▶ Switch device off and back on again. If the error recurs: 1. Switch off device. 2. Activate emergency lid release (see <i>Open centrifuge in the event of a power failure</i> on page 48).
Error 30 Lid latch	Centrifuge lid has not been opened wide enough.	▶ Open centrifuge lid wider by hand.

8.3 Open centrifuge in the event of a power failure

If the centrifuge lid cannot be opened in the event of a power failure, you can activate the emergency lid release manually.



Warning! Risk of injury from rotating rotor if the emergency lid release is activated.

- ▶ Wait for rotor to stop before activating emergency lid release.
- ▶ To check, look through the inspection glass in the centrifuge lid.



To operate the emergency lid release use the rotor key supplied with the Centrifuge 5430 / 5430 R. The rotor key for rotor FA-45-24-11-HS is not suitable for this purpose.

1. Disconnect the mains plug.
2. Carry out the following steps for the emergency lid release on both the left and right-hand sides of the centrifuge (see Fig. 1 on page 10).
3. **Only 5430:** Remove the plastic cover for the emergency lid release.
4. Enter the rotor key of the centrifuge into the hexagonal opening behind until some resistance can be felt.
5. Slightly press and turn the rotor key five to ten revolutions counterclockwise, as depicted on the openings of the emergency lid release.
This will unlatch the centrifuge lid.
6. Open the centrifuge lid.
7. Remove the rotor key and put the plastic covers back on (Centrifuge 5430).

9 Transport, storage and disposal

9.1 Transport

- ▶ Only transport the device in the original packaging.
- ▶ Use a transport aid for transporting over longer distances.

	Air temperature	Rel. humidity	Air pressure
General transportation	-25 to 60 °C	10 to 75%	30 to 106 kPa
Air freight	-20 to 55 °C	10 to 75%	30 to 106kPa

9.2 Storage

	Air temperature	Rel. humidity	Air pressure
in transport packaging	-25 to 55 °C	10 to 75%	70 to 106 kPa
without transport packaging	-5 to 45 °C	10 to 75%	70 to 106 kPa

9.3 Disposal

In the event of disposing of the product, please observe the applicable legal regulations.

Information on the disposal of electrical and electronic devices in the European Community:

The disposal of electrical devices is regulated within the European Community by national regulations based on EU Directive 2002/96/EC pertaining to waste electrical and electronic equipment (WEEE).

In accordance with this, any devices delivered after 13/08/2005 on a business-to-business basis, which includes this product, may no longer be disposed of in household waste. To document this they have been marked with the following identification:



Because disposal regulations may differ from one country to another within the EU please contact your supplier if necessary.

10 Technical data

10.1 Power supply

10.1.1 Centrifuge 5430

Mains power connection	230 V, 50 to 60 Hz 120 V, 50 to 60 Hz 100 V, 50 to 60 Hz
Current consumption:	3 A (230 V) 6 A (120 V) 7 A (100 V)
Power consumption:	max. 475 W
EMC: Interference emission (radio interference)	EN 61326 - category B
EMC: Noise immunity	EN 61326 - performance characteristic B
Overvoltage category:	II
Fuses:	4.0 AT (230 V) 8.0 AT (120 V / 100 V)

10.1.2 Centrifuge 5430 R

Mains power connection	230 V, 50 to 60 Hz 120 V, 50 to 60 Hz 100 V, 50 to 60 Hz
Current consumption:	6 A (230 V) 12 A (120 V / 100 V)
Power consumption:	max. 1050 W
EMC: Interference emission (radio interference)	EN 61326 - category B
EMC: Noise immunity	EN 61326 - performance characteristic B
Overvoltage category:	II
Fuses:	Thermal overcurrent protection switch 7 A (230 V) Thermal overcurrent protection switch 15 A (120 V / 100 V)

10.2 Ambient conditions

Environment:	For indoor use only.
Ambient temperature:	Centrifuge 5430: 4 up to 40 °C Centrifuge 5430 R: 10 up to 40 °C
Max. relative humidity:	75 %, non-condensing humidity
Atmospheric pressure:	Use up to an altitude of 2000 m above MSL.
Degree of contamination:	2

10 Technical data

10.3 Weight / dimensions

10.3.1 Centrifuge 5430

Dimensions:	Width: 335 mm (11.2 in.) Depth: 415 mm (16.3 in.) Height: 250 mm (9.84 in.)
Weight excl. rotor:	29 kg (63.9 lbs.)
Noise level:	< 67 dB(A)

10.3.2 Centrifuge 5430 R

Dimensions:	Width: 380 mm (15.0 in.) Depth: 640 mm (25.2 in.) Height: 296 mm (11.7 in.)
Weight excl. rotor:	56 kg (123.5 lbs.)
Noise level:	< 63 dB(A)

10.4 Application parameters

Runtime:	30 s to 99:59 h, infinite (∞), adjustable up to 10 min. in 0.5 min. increments, thereafter in 1 min. increments.
Temperature (only 5430 R):	-11 °C to 40 °C
Relative centrifugal force (rcf):	1 to 30.130 x g, adjustable up to 3.000 x g in 10 x g increments, thereafter in 100 x g increments.
Speed:	100 to 17.500 rpm, adjustable up to 5.000 rpm in 10 rpm increments, thereafter in 100 rpm increments.
Max. load:	30 micro test tubes of 2.0 ml or 6 Falcon test tubes of 50 ml.
Max. kinetic energy:	10,000 Nm
Test log mandatory:	No
Permitted density of the centrifugate (at max. g-force/rpm and max. load):	1.2 g/ml

Start and stop times according to DIN 58 970

Rotor	Without soft ramp	With soft ramp (SOFT)
FA-45-30-11,	14 s / 15 s	60 s / 65 s
F-45-30-11	14 s / 15 s	60 s / 65 s
FA-45-24-11-HS	21 s / 16 s	60 s / 65 s
FA-45-24-11-Kit	14 s / 16 s	68 s / 90 s
F-45-64-5-PCR	12 s / 15 s	60 s / 65 s
F-45-18-17-Cryo	8 s / 11 s	67 s / 85 s
F-35-6-30	23 s / 23 s	60 s / 67 s
A-2-MTP	17 s / 21 s	62 s / 67 s

These values were calculated for 230 V and 120 V at 23 °C.

11 Ordering information

11.1 Centrifuge 5430

Order No. (International)	Order No. (North America)	Description
5427 000.011 -	022620533 022620584	Centrifuge 5430, Keypad without rotor 230 V / 50 - 60 Hz 120 V / 50 - 60 Hz, with US-plug
5427 000.216 -	022620525 022620509	Centrifuge 5430, Keypad with rotor FA-45-30-11 incl. rotor lid 230 V / 50 - 60 Hz 120 V / 50 - 60 Hz, with US-plug
-	022620541	Centrifuge 5430, Keypad with rotor FA-45-24-11-Kit incl. rotor lid 120 V / 50 - 60 Hz, with US-plug
-	022620568	Centrifuge 5430, Keypad with rotor A-2-MTP incl. wind shield upper shell 120 V / 50 - 60 Hz, with US-plug
5427 000.615 -	022620540 022620596	Centrifuge 5430, Knobs without rotor 230 V / 50 - 60 Hz 120 V / 50 - 60 Hz, with US-plug
5427 000.410 -	- 022620511	Centrifuge 5430, Knobs with rotor FA-45-30-11 incl. rotor lid 230 V / 50 - 60 Hz 120 V / 50 - 60 Hz, with US-plug
-	022620557	Centrifuge 5430, Knobs with rotor FA-45-24-11-Kit incl. rotor lid 120 V / 50 - 60 Hz, with US-plug
-	022620572	Centrifuge 5430, Knobs with rotor A-2-MTP incl. wind shield upper shell 120 V / 50 - 60 Hz, with US-plug

11 Ordering information

11.2 Centrifuge 5430 R

Order No. (International)	Order No. (North America)	Description
5428 000.210 -	022620678 022620667	Centrifuge 5430 R, Keypad without rotor 230 V / 50 - 60 Hz 120 V / 50 - 60 Hz, with US-plug
5428 000.015 -	022620612 022620601	Centrifuge 5430 R, Keypad with rotor FA-45-30-11 incl. rotor lid 230 V / 50 - 60 Hz 120 V / 50 - 60 Hz, with US-plug
-	022620645	Centrifuge 5430 R, Keypad with rotor A-2-MTP incl. wind shield upper shell 120 V / 50 - 60 Hz, with US-plug
5428 000.619 -	022620690 022620689	Centrifuge 5430 R, Knobs without rotor 230 V / 50 - 60 Hz 120 V / 50 - 60 Hz, with US-plug
5428 000.414 -	022620634 022620623	Centrifuge 5430 R, Knobs with rotor FA-45-30-11 incl. rotor lid 230 V / 50 - 60 Hz 120 V / 50 - 60 Hz, with US-plug
-	022620656	Centrifuge 5430 R, Knobs with rotor A-2-MTP incl. wind shield upper shell 120 V / 50 - 60 Hz, with US-plug

11 Ordering information

11.3 Accessories

11.3.1 Rotors and rotor lids

Order No. (International)	Order No. (North America)	Description
5427 713.000	022654047	Rotor FA-45-30-11 aerosol-tight*, PTFE-coated, angle 45°, 30 places, max. tube diameter 11 mm, incl. rotor lid (aluminum)
5427 719.008	022654063	Rotor lid for FA-45-30-11 aerosol-tight*, PTFE-coated, aluminum
5427 712.003	022654004	Rotor F-45-30-11 PTFE-coated, angle 45°, 30 places, max. tube diameter 11 mm, incl. rotor lid (polypropylene)
5427 718.001	022654021	Rotor lid for F-45-30-11 Polypropylen
5427 710.000	022654080	Rotor FA-45-24-11-HS aerosol-tight*, PTFE-coated, angle 45°, 24 places, max. tube diameter 11 mm, incl. rotor lid (aluminum)
5427 711.007	022654101	Rotor lid for FA-45-24-11-HS aerosol-tight*, PTFE-coated, aluminum
5427 703.004	022654128	Rotor FA-45-24-11-Kit aerosol-tight*, angle 45°, 24 places, max. tube diameter 11 mm, incl. rotor lid (aluminum)
5427 704.000	022654144	Rotor lid for FA-45-24-11-Kit aerosol-tight*, aluminum
5427 714.006	022654209	Rotor F-45-64-5-PCR angle 45°, 64 places, max. tube diameter 5 mm, incl. rotor lid (aluminum) and adapters
5427 720.006	022654225	Rotor lid for F-45-64-5-PCR aluminum
5427 705.007	022654161	Rotor F-45-18-17-Cryo angle 45°, 18 places, max. tube diameter 17 mm, incl. rotor lid (polypropylene) and adapters
5427 707.000	022654187	Rotor lid for F-45-18-17-Cryo polypropylene
5427 716.009	022654306	Rotor F-35-6-30 angle 35°, 6 places, max. tube diameter 30 mm, incl. rotor lid (aluminum) and adapters for 15/50 mL Falcon tubes
5427 715.002	022654322	Rotor lid for F-35-6-30 aluminium
5427 700.005	022634403	Rotor A-2-MTP incl. 2 MTP buckets and wind shield upper shell (aluminum)
5427 722.009	022634420	Spare MTP buckets for A-2-MTP Set of 2
5427 725.008	022654446	Wind shield upper shell for A-2-MTP aluminum

*) Aerosol impermeability tested and certified by the Centre of Emergency Preparedness and Response, Health Protection Agency, Porton Down (UK).

11 Ordering information

11.3.2 Adapters

Order No. (International)	Order No. (North America)	Description
5425 715.005	022636260	Adapter used in FA-45-30-11, FA-45-30-11-Special, F-45-30-11, F-45-48-11, FA-45-24-11-HS and FA-45-24-11-Kit for 0.2 mL PCR tubes, set of 6
5425 717.008	022636243	Adapter used in FA-45-30-11, F-45-30-11, FA-45-24-11-HS and FA-45-24-11-Kit for 0.4 mL tubes, set of 6
5425 716.001	022636227	Adapter used in FA-45-30-11, F-45-30-11, F-45-48-11, FA-45-24-11-HS and FA-45-24-11-Kit for 0.5 mL tubes and 0.6 mL Microtainer, set of 6
5427 717.005	022654241	Adapter used in rotor F-45-64-5-PCR for PCR strips, set of 4 pcs.
5702 752.002	022639498	Adapter used in F-45-18-17-Cryo for cryo tubes (max. diameter 13 mm) and sealable centrifugation tubes (max. diameter 12.2 mm), set of 6
5427 727.000 5427 726.004 5427 723.005	022654349 022654365 022654331	Adapter used in F-35-6-30 for 50 mL Falcon tubes, set of 2 for 15 mL Falcon tubes, set of 2 for Centriplus centrifugal filter units, set of 6
5825 711.009 5825 713.001	022638947 022638955	Adapter used in A-2-MTP for 96-well PCR plates, set of 2 for 384-well PCR plates, set of 2
5825 706.005	022638963	Adapter used in A-2-MTP, A-2-DWP, A-4-62-MTP, A-4-81-MTP/Flex and A-2-VC CombiSlide adapter, set of 2

11.3.3 Other accessories

Order No. (International)	Order No. (North America)	Description
5416 301.001 5427 350.012	022634305 5427 350.012	Rotor key Standard for rotor FA-45-24-11-HS
5427 728.007	5427 728.007	Rotor removal tool for Rotor F-35-6-30
5810 350.050	022634330	Pivot grease Tube 20 mL
5703 350.102	022639609	Captain Eppi rotor key holder 1 piece
5428 850.418	022680452	Condensation water tray

11.3.4 Fuses for Centrifuge 5430

Order No. (International)	Order No. (North America)	Description
5301 850.249 5427 355.200	022654403 022654381	Fuses 2 x 4.0 AT (230 V) 2 x 8,0 AT (120 V/100 V), 5 x 20 mm

12 Declarations and Certificates

EG-Konformitätserklärung EC Conformity Declaration

Das bezeichnete Produkt entspricht den einschlägigen grundlegenden Anforderungen der aufgeführten EG-Richtlinien und Normen. Bei einer nicht mit uns abgestimmten Änderung des Produktes oder einer nicht bestimmungsgemäßen Anwendung verliert diese Erklärung ihre Gültigkeit.

The product named below fulfills the relevant fundamental requirements of the EC directives and standards listed. In the case of unauthorized modifications to the product or an unintended use this declaration becomes invalid.

Produktbezeichnung, Product name:

Centrifuge 5430

einschließlich Zubehör / including accessories

Produkttyp, Product type:

Laborzentrifuge / Laboratory Centrifuge

Einschlägige EG-Richtlinien/Normen, Relevant EC directives/standards:

2006/95/EG, EN 61010-1, EN 61010-2-20 2006/42/EG, EN 1050, EN ISO 12100-2

2004/108/EG, EN 61000-3-2, EN 61000-3-3, EN 61000-4-14, EN 61326-1

98/79/EG, EN 14971, EN 61010-2-101, EN 61326-2-6

H.-G. Köhl *P. Ferrei*

Vorstand, Board of Management:

Projektmanagement, Project Management:

08.11.2007

Hamburg, Date:



eppendorf

Eppendorf AG · Barkhausenweg 1 · 22339 Hamburg · Germany

12 Declarations and Certificates

Certificate of Compliance

Certificate Number 090806 - E215059
Report Reference E215059, June 9th, 2006
Issue Date 2006 August 9

Page 1 of 2



Issued to: **EPPENDORF A G**
BARKHAUSENWEG 1
D-22339 HAMBURG GERMANY

This is to certify that representative samples of

Centrifuge
Model: 5430

Have been investigated by Underwriters Laboratories Inc.® in accordance with the Standard(s) indicated on this Certificate.

Standard(s) for Safety: See Addendum for Safety

Additional Information: **ELECTRICAL RATING:**
Voltage: 120 V ac
Frequency: 50-60 Hz
Current: 6 A
Power: 460 W

Only those products bearing the UL Listing Mark for the US and Canada should be considered as being covered by UL's Listing and Follow-Up Service meeting the appropriate requirements for US and Canada.
The UL Listing Mark for the US and Canada generally includes: the UL in a circle symbol with "C" and "US" identifiers:  the word "LISTED"; a control number (may be alphanumeric) assigned by UL; and the product category name (product identifier) as indicated in the appropriate UL Directory.

Look for the UL Listing Mark on the product

Issued by: **Walter Hofmair**
Walter Hofmair, Senior Project Engineer
UL International Germany GmbH
Any information and documentation provided to you involving UL Mark services are provided on behalf of Underwriters Laboratories Inc.UL International Germany GmbH

Reviewed by: **Manfred Müller**
Manfred Müller, Senior Project Engineer
UL International Germany GmbH

12 Declarations and Certificates

Certificate of Compliance

Certificate Number 090806 - E215059
Report Reference E215059, June 9th, 2006
Issue Date 2006 August 9

Page 2 of 2



This is to verify that representative samples of the product as specified on this certificate were tested according to the current UL, cUL requirements.

- UL 61010-1 Electrical Equipment for Laboratory Use; Part 1: General Requirements
- UL 61010A-1 Electrical Equipment for Laboratory Use; Part 1: General Requirements
- UL 61010A-2-020 Electrical Equipment for Laboratory Use; Part 2: Particular Requirements for Laboratory Centrifuges
- CSA C22.2 No. 1010.1 Electrical Equipment for Measurement, Control and Laboratory Use; Part 1: General Requirements
- CSA C22.2 No.1010.2.020, CSA-C22.2 No. 1010.2.020A Electrical Equipment for Laboratory Use; Part 2: Particular Requirements for Laboratory Centrifuges

Issued by: **Walter Hofmair**
Walter Hofmair, Senior Project Engineer
UL International Germany GmbH
Any information and documentation provided to you involving UL Mark services are provided on behalf of Underwriters Laboratories Inc.UL International Germany GmbH

Reviewed by: **Manfred Müller**
Manfred Müller, Senior Project Engineer
UL International Germany GmbH

12 Declarations and Certificates

Certificate of Compliance

Certificate Number 261107 - E215059
Report Reference E215059, October 31, 2007
Issue Date 2007 November 26

Page 1 of 2



Issued to: **EPPENDORF A G**
BARKHAUSENWEG 1
D-22339 HAMBURG GERMANY

This is to certify that representative samples of **Centrifuge**
Model 5430R, 5428

Have been investigated by Underwriters Laboratories Inc.® (UL) or any authorized licensee of UL in accordance with the Standard(s) indicated on this Certificate.

Standard(s) for Safety: See Addendum for Standards

Additional Information: See Addendum for Ratings

Only those products bearing the UL Listing Mark for the US and Canada should be considered as being covered by UL's Listing and Follow-Up Service meeting the appropriate requirements for US and Canada.

The UL Listing Mark for the US and Canada generally includes: the UL in a circle symbol with "C" and "US" identifiers:  the word "LISTED"; a control number (may be alphanumeric) assigned by UL; and the product category name (product identifier) as indicated in the appropriate UL Directory.

Look for the UL Listing Mark on the product

Issued by: *Kiya Ghamari*
Kiya Ghamari, Associate Project Engineer
UL International Germany GmbH
Any information and documentation provided to you involving UL Mark services are provided on behalf of Underwriters Laboratories Inc. UL International Germany GmbH

Reviewed by: *Walter Hofmair*
Walter Hofmair, Senior Project Engineer
UL International Germany GmbH

12 Declarations and Certificates

Certificate of Compliance

Certificate Number 261107 - E215059
 Report Reference E215059, October 31, 2007
 Issue Date 2007 November 26

Page 2 of 2



This is to verify that representative samples of the product as specified on this certificate were tested according to the current UL, cUL requirements.

Standards:

UL 61010-1 - Electrical Equipment for Laboratory Use; Part 1: Second Edition; Part 2: Particular Requirements for Laboratory Centrifuges, IEC 61010-2-020, 2006.

CSA C22.2 No. 61010-1 - Electrical Equipment for Measurement, Control and Laboratory Use; Part 1: General Requirements Second Edition; Part 2: Particular Requirements for Laboratory Centrifuges, IEC 61010-2-020, 2006

ELECTRICAL RATING:

Voltage: 120 V ac
 Frequency: 50-60 HZ
 Current: 12 A
 Power: 1050 W

MECH. RATING:

Max. Speed: 17 500 RPM
 Kinetic energy: 10 000 Nm
 Max, density of Liquid: 1.2 kg/dm³

Issued by: *Kiya Ghamari*
 Kiya Ghamari, Associate Project Engineer

UL International Germany GmbH

Any information and documentation provided to you involving UL Mark services are provided on behalf of Underwriters Laboratories Inc. UL International Germany GmbH

Reviewed by: *Walter Hofmair*
 Walter Hofmair, Senior Project Engineer

UL International Germany GmbH

12 Declarations and Certificates

Centre of Emergency Preparedness and Response
Health Protection Agency
Porton Down
Salisbury
Wiltshire SP4 0JG
United Kingdom



Certificate of Containment Testing

Rotor FA 45-30-11 (5427 713.107-00)
with sealed lid in Eppendorf centrifuge
5430

Report No. 955-05

Report prepared for: Eppendorf AG, Hamburg, Germany
Issue Date: 2nd June 2005

Test Summary

The FA 45-30-11 rotor (5427 713.107-00) was containment tested in the Eppendorf centrifuge 5430, using Annex AA of IEC 1010-2-20. The rotor was shown to contain a large spill within the rotor.

Report Written By

A blue ink signature written over a horizontal dashed line.

Report Authorised By

A blue ink signature written over a horizontal dashed line.

12 Declarations and Certificates

Centre for Emergency Preparedness and Response



Centre of Emergency Preparedness and Response
Health Protection Agency
Porton Down
Salisbury
Wiltshire SP4 0JG
United Kingdom

Certificate of Containment Testing

**Rotor FA 45-24-11-HS
(5427 710.108-01) with sealed lid in
Eppendorf centrifuge 5430**

Report No. 980-05 B

Report prepared for: Eppendorf AG, Hamburg, Germany
Issue Date: 8th November 2005

Test Summary

The FA 45-24-11-HS rotor (5427 710.108-01) was containment tested in the Eppendorf centrifuge 5430, using Annex AA of IEC 1010-2-20. The rotor was shown to contain a large spill within the rotor.

Report Written By

A blue ink signature written over a horizontal dashed line.

Report Authorised By

Two blue ink signatures written over a horizontal dashed line.

12 Declarations and Certificates

Centre of Emergency Preparedness and Response
Health Protection Agency
Porton Down
Salisbury
Wiltshire SP4 0JG
United Kingdom



Certificate of Containment Testing

**Rotor FA 45-24-11-KIT (5427 703.101-00)
with sealed lid in Eppendorf centrifuge
5430**

Report No. 956-05

Report prepared for: Eppendorf AG, Hamburg, Germany
Issue Date: 7th June 2005

Test Summary

The FA 45-24-11-KIT rotor (5427 703.101-00) was containment tested in the Eppendorf centrifuge 5430, using Annex AA of IEC 1010-2-20. The rotor was shown to contain a large spill within the rotor.

Report Written By



A blue ink signature written over a horizontal dashed line.

Report Authorised By

A blue ink signature written over a horizontal dashed line.

12 Declarations and Certificates

Tab. 1: Menu structure of the Centrifuge 5430 / 5430 R in four different menu languages.

English	Deutsch	Français	Español	Display
Programs <ul style="list-style-type: none"> • Load program • Save program • Delete program 	Programme <ul style="list-style-type: none"> • Programm laden • Programm speichern • Programm löschen 	Programmes <ul style="list-style-type: none"> • Charger prog. • Enregistrer prog. • Supprimer prog. 	Programas <ul style="list-style-type: none"> • Cargar programa • Guardar programa • Borrar programa 	
Soft ramp <ul style="list-style-type: none"> • On • Off 	Soft ramp <ul style="list-style-type: none"> • An • Aus 	Rampe douce <ul style="list-style-type: none"> • Marche • Arrêt 	Rampa suave <ul style="list-style-type: none"> • Encendido • Apagado 	SOFT
Key lock <ul style="list-style-type: none"> • On • Off 	Key lock <ul style="list-style-type: none"> • An • Aus 	Verrouilla. de touches <ul style="list-style-type: none"> • Marche • Arrêt 	Bloqueo del teclado <ul style="list-style-type: none"> • Encendido • Apagado 	
At set rpm <ul style="list-style-type: none"> • On • Off 	At set rpm <ul style="list-style-type: none"> • An • Aus 	At set rpm <ul style="list-style-type: none"> • Marche • Arrêt 	At set rpm <ul style="list-style-type: none"> • Encendido • Apagado 	
Short Spin <ul style="list-style-type: none"> • Maximum speed • Current speed 	Short Spin <ul style="list-style-type: none"> • Maximaler Wert • Aktueller Wert 	Short Spin <ul style="list-style-type: none"> • Vitesse max • Vitesse actuelle 	Short Spin <ul style="list-style-type: none"> • Velocidad máximo • Velocidad actual 	
Continuous cooling (5430 R) <ul style="list-style-type: none"> • 8 h • ∞ 	Dauerkühlung (5430 R) <ul style="list-style-type: none"> • 8 h • ∞ 	Refrigeration continue (5430 R) <ul style="list-style-type: none"> • 8 h • ∞ 	Refrigeración continua (5430 R) <ul style="list-style-type: none"> • 8 h • ∞ 	
Fast Temp pro (5430 R) <ul style="list-style-type: none"> • One-time use • Repeated use 	Fast Temp pro (5430 R) <ul style="list-style-type: none"> • Einmal • Mehrmals 	Fast Temp pro (5430 R) <ul style="list-style-type: none"> • Une fois • Plusieurs fois 	Fast Temp pro (5430 R) <ul style="list-style-type: none"> • Una vez • Varias veces 	FTPro
Settings <ul style="list-style-type: none"> • Display <ul style="list-style-type: none"> – Standard display – Extended display • Alarm <ul style="list-style-type: none"> – On – Off • Volume <ul style="list-style-type: none"> – Cancel – Save – Default • Date/Time • Contrast <ul style="list-style-type: none"> – Cancel – Save – Default • Language <ul style="list-style-type: none"> – English – Deutsch – Français – Español • Standby <ul style="list-style-type: none"> – On – Off – Set time • Lid release (5430) <ul style="list-style-type: none"> – Automatic – Manual 	Einstellungen <ul style="list-style-type: none"> • Anzeige <ul style="list-style-type: none"> – Standardanzeige – Erweiterte Anzeige • Lautsprecher <ul style="list-style-type: none"> – An – Aus • Lautstärke <ul style="list-style-type: none"> – Abbrechen – Speichern – Lieferzustand • Datum/Uhrzeit • Kontrast <ul style="list-style-type: none"> – Abbrechen – Speichern – Lieferzustand • Sprache <ul style="list-style-type: none"> – English – Deutsch – Français – Español • Standby <ul style="list-style-type: none"> – An – Aus – Zeit einstellen • Deckelöffnung (5430) <ul style="list-style-type: none"> – Automatisch – Manuell 	Réglages <ul style="list-style-type: none"> • Affichage <ul style="list-style-type: none"> – Affichage standard – Affichage large • Signal sonore <ul style="list-style-type: none"> – Marche – Arrêt • Volume <ul style="list-style-type: none"> – Annuler – Enregistrer – Réglage usine • Date/Heure • Contraste <ul style="list-style-type: none"> – Annuler – Enregistrer – Réglage usine • Langue <ul style="list-style-type: none"> – English – Deutsch – Français – Español • Mise en veille <ul style="list-style-type: none"> – Marche – Arrêt – Réglage du temps • Ouverture couvercle (5430) <ul style="list-style-type: none"> – Automatique – Manuelle 	Ajustes <ul style="list-style-type: none"> • Indicador <ul style="list-style-type: none"> – Indicador estándar – Indicador extendido • Altavoz <ul style="list-style-type: none"> – Encendido – Apagado • Volume <ul style="list-style-type: none"> – Cancelar – Guardar – Est. de Fábrica • Fecha/Hora • Contraste <ul style="list-style-type: none"> – Cancelar – Guardar – Est. de Fábrica • Idioma <ul style="list-style-type: none"> – English – Deutsch – Français – Español • Standby <ul style="list-style-type: none"> – Encendido – Apagado – Establecer tiempo • Apertura de la tapa (5430) <ul style="list-style-type: none"> – Automática – Manual 	

5430: only for Centrifuge 5430
5430 R: only for Centrifuge 5430 R

Eppendorf offices

AUSTRALIA & NEW ZEALAND

Eppendorf South Pacific Pty. Ltd.
Phone: +61 2 9889 5000
Fax: +61 2 9889 5111
E-mail: Info@eppendorf.com.au
Internet: www.eppendorf.com.au

AUSTRIA

Eppendorf Austria
Phone: +43 1 29017560
Fax: +43 1 290175620
E-mail: office@eppendorf.at
Internet: www.eppendorf.at

BRAZIL

Eppendorf do Brasil Ltda.
Phone: +55 11 30 95 93 44
Fax: +55 11 30 95 93 40
E-mail: eppendorf@eppendorf.com.br
Internet: www.eppendorf.com.br

CANADA

Eppendorf Canada Ltd.
Phone: +1 905 826 5525
Fax: +1 905 826 5424
E-mail: canada@eppendorf.com
Internet: www.eppendorfna.com

CHINA

Eppendorf China Ltd.
Phone: +86 21 68760880
Fax: +86 21 50815371
E-mail: market.info@eppendorf.cn
Internet: www.eppendorf.cn

CZECH REP. & SLOVAKIA

Eppendorf Czech & Slovakia s.r.o.
Phone: +420 323 605 454
Fax: +420 323 605 454
E-mail: eppendorf@eppendorf.cz
Internet: www.eppendorf.cz /
www.eppendorf.sk

FRANCE

Eppendorf France S.A.R.L.
Phone: +33 1 30 15 67 40
Fax: +33 1 30 15 67 45
E-mail: eppendorf@eppendorf.fr
Internet: www.eppendorf.fr

GERMANY

Eppendorf Vertrieb
Deutschland GmbH
Phone: +49 2232 418-0
Fax: +49 2232 418-155
E-mail: vertrieb@eppendorf.de
Internet: www.eppendorf.de

INDIA

Eppendorf India Limited
Phone: +91 44 42 11 13 14
Fax: +91 44 42 18 74 05
E-mail: info@eppendorf.co.in
Internet: www.eppendorf.co.in

ITALY

Eppendorf s.r.l.
Phone: +390 2 55 404 1
Fax: +390 2 58 013 438
E-mail: eppendorf@eppendorf.it
Internet: www.eppendorf.it

JAPAN

Eppendorf Co. Ltd.
Phone: +81 3 5825 2363
Fax: +81 3 5825 2365
E-mail: info@eppendorf.jp
Internet: www.eppendorf.jp

NORDIC

Eppendorf Nordic Aps
Phone: +45 70 22 2970
Fax: +45 45 76 7370
E-mail: nordic@eppendorf.dk
Internet: www.eppendorf.dk

SOUTH & SOUTHEAST ASIA

Eppendorf Asia Pacific Sdn. Bhd.
Phone: +60 3 8023 2769
Fax: +60 3 8023 3720
E-mail:
eppendorf@eppendorf.com.my
Internet: www.eppendorf.com.my

SPAIN

Eppendorf Ibérica S.L.U.
Phone: +34 91 651 76 94
Fax: +34 91 651 81 44
E-mail: iberica@eppendorf.es
Internet: www.eppendorf.es

SWITZERLAND

Vaudaux-Eppendorf AG
Phone: +41 61 482 1414
Fax: +41 61 482 1419
E-mail: vaudaux@vaudaux.ch
Internet: www.eppendorf.ch

UNITED KINGDOM

Eppendorf UK Limited
Phone: +44 1223 200 440
Fax: +44 1223 200 441
E-mail: sales@eppendorf.co.uk
Internet: www.eppendorf.co.uk

USA

Eppendorf North America, Inc.
Phone: +1 516 334 7500
Fax: +1 516 334 7506
E-mail: info@eppendorf.com
Internet: www.eppendorfna.com

OTHER COUNTRIES

Internet: www.eppendorf.com/worldwide

eppendorf

In touch with life

Your local distributor: www.eppendorf.com/worldwide

Eppendorf AG · 22331 Hamburg · Germany · Tel: +49 40 538 01-0 · Fax: +49 40 538 01-556 · E-Mail: eppendorf@eppendorf.com

Eppendorf North America, Inc. · One Cantiague Road · P.O. Box 1019 · Westbury, N.Y. 11590-0207 · USA
Tel: +1 516 334 7500 · Toll free phone: +1 800 645 3050 · Fax: +1 516 334 7506 · E-Mail: info@eppendorf.com

Application Support

Europe, International: Tel: +49 1803 666 789 · E-Mail: support@eppendorf.com
North America: Tel: +1 800 645 3050 ext. 2258 · E-Mail: support_na@eppendorf.com
Asia Pacific: Tel: +60 3 8023 6869 · E-Mail: support_asiapacific@eppendorf.com