

Operating instructions

Washer-disinfector

PG 8536

To avoid the risk of accidents or damage to the machine it is **essential** to read these instructions before it is installed, commissioned and used for the first time.

en - GB, AU, NZ

M.-Nr. 10 317 371

Contents

Warning and safety instructions	5
Correct application	5
Symbols on the appliance	9
Intended Use	10
User profile	11
Description of the machine	12
Controls	13
Display	15
An example of a selected list	15
An example of a programme sequence display	16
Context menu	17
Change display language	18
Changing operating level	19
Delay start	21
Current faults	23
Reactivation	23
Opening and closing the door	24
Electric door lock	24
To open the door with the emergency release	24
Water softener	25
Setting the water softener	25
Reactivation display	25
Reactivating the water softener	26
Filling the salt container	26
Position the salt container as follows	26
Run the reactivation programme	27
Automatic mobile unit recognition	28
Spray arm monitoring	29
Areas of application	30
Protein test	30
Loading the machine	31
Water connection spring adapter	32
Height adjustable top basket	32
Surgical instruments (OP)	33
Ophthalmology	34
Anaesthetic instruments (AN)	35
Baby bottles (BC)	36

Operating theatre shoes	37
Laboratory glassware (LG)	38
Chemical processes and technology	40
Dispensing liquid chemical agents	45
Dispensing systems.	46
"Fill DOX [X] container" message	46
Fill the containers with the relevant agent	47
"Check dispensing system [X]"	48
Venting the dispensing system.	48
Operation	49
Switching on	49
Reset button	49
Starting the programme.	49
Programme sequence	50
At the end of the programme.	50
Switching off	50
Cancelling a programme.	51
Interrupting a programme	52
Process documentation	53
Maintenance	54
Periodic checks	54
Process validation	54
Routine checks	54
Cleaning the filters in the wash cabinet.	55
Cleaning the coarse filter	55
Cleaning the coarse, flat and micro-fine filters	56
Cleaning the spray arms	57
Cleaning the control panel.	58
Cleaning the front of the machine	58
Cleaning the wash cabinet	58
Cleaning the door seals.	58
Mobile units, baskets and inserts	59
Drying unit (TA) - Maintenance	60
Changing the coarse filter	60
Changing the fine filter	61

Contents

Problem solving	62
Thermal cut-out	62
Cleaning the filters in the water inlet	63
After sales service	64
Installation	65
Electrical connection	66
Plumbing	67
Connection to the water inlet	67
AD water connection (pressurised) > 60 - 1000 kPa over pressure	68
Optional AD water connection (without pressure) 8.5 - 60 kPa	68
IMPORTANT	
Australia and New Zealand	69
Drainage	70
Technical data	71
Optional extras	72
Special processes - OXIVARIO and ORTHOVARIO	73
Intended use	73
Areas of application	73
Warning and Safety instructions	74
Connecting the H ₂ O ₂ solution container	74
Disposal of your old machine	75

Warning and safety instructions

This washer-disinfector complies with all relevant local and national safety requirements. Please note that incorrect use can lead to personal injury and damage to property.

To avoid the risk of accidents and damage to the washer-disinfector, please read these instructions carefully before starting to use it. Keep these instructions in a safe place for reference, and pass them on to any future user.

Correct application

► This washer-disinfector is designed for use with the applications described in these Operating Instructions only. Alterations or conversions to the machine, or using it for purposes other than those for which it was designed, are not permitted and could be dangerous.

This washer-disinfector must only be used for cleaning and disinfecting instruments, medical devices and laboratory equipment if the manufacturer has stated that they are suitable for machine reprocessing.

Manufacturer's cleaning and maintenance instructions for instruments etc. must also be observed.

Miele cannot be held liable for damage caused by improper or incorrect use or operation of the machine.

► This washer-disinfector is intended for stationary, indoor use only.

Please pay attention to the following notes to avoid injury and damage.

► This washer-disinfector should be commissioned and then maintained by a Miele authorised and trained service technician only. A Miele service contract is recommended to ensure compliance with GLP Guidelines and the Medical Device Directive.

Unauthorised repairs could be dangerous and jeopardise the personal safety of the operator.

► Do not install the washer-disinfector in an area where there is any danger of explosion or of freezing conditions.

► The electrical safety of this washer-disinfector can only be guaranteed when correctly earthed. It is most important that this basic safety requirement is observed and regularly tested, and where there is any doubt the on-site wiring system should be inspected by a qualified electrician. The manufacturer cannot be held liable for damage or injury caused by the lack of or inadequacy of an effective earthing system (e.g. electric shock).

► A damaged or leaking washer-disinfector could be dangerous and compromise your safety. Disconnect the machine from the mains immediately and call the Miele Service Department.

► Personnel operating the machine should be trained regularly. Untrained personnel and children must not be allowed access to the machine or its controls.

Warning and safety instructions

▶ Take care when handling chemical agents such as cleaning agent, neutralising agent, rinsing agent etc. These may contain irritant or corrosive ingredients.

Please follow the manufacturer's safety instructions. Wear protective gloves and goggles. With all chemical agents, the manufacturer's safety instructions and safety data sheets must be observed.

▶ The washer-disinfector is designed for operation with water and recommended additive chemical agents only. Organic solvents and flammable liquid agents must not be used in this machine.

These could cause an explosion, damage rubber and plastic components in the machine, and cause liquids to leak out of the machine.

▶ The water in the cabinet must not be used as drinking water.

▶ Do not sit or lean on an open door. The machine could tip up and be damaged or cause an injury.

▶ Be careful when sorting items with sharp pointed ends and positioning them in the machine that you do not hurt yourself or create a danger for others. Sharp knives etc. should be placed in baskets with the pointed ends facing downwards.

▶ Please be aware that the washer-disinfector may be operating at high temperatures. If the door is opened with the emergency release cord, there is a danger of burning, scalding or chemical burning or if disinfecting agents are used there is a danger of inhaling toxic vapours.

▶ Where there is a risk of toxic or chemical substances occurring in the suds solution (e.g. aldehyde in the disinfecting agent), it is essential to regularly check door seals and make sure that the steam condenser is functioning correctly.

Opening the machine door during a programme interruption carries particular risks in such circumstances.

▶ Should personnel accidentally come into contact with toxic vapours or chemical agents, follow the emergency instructions given in the manufacturer's safety data sheets.

▶ Mobile units, modules, inserts and the load must be allowed to cool down before unloading the machine. Any water remaining in containers could still be very hot. Empty them into the wash cabinet before taking them out.

▶ After using the hot air drying unit, open the door to allow everything in the cabinet from the load itself to the mobile units, modules and inserts to cool down.

▶ Do not touch the heating elements if you open the door directly after the end of a programme; you could burn yourself. They remain hot for some time after the end of the programme.

Warning and safety instructions

- ▶ Never clean the machine or near vicinity with a water hose or a pressure washer.
- ▶ The machine must be disconnected from the mains electricity supply before any maintenance or repair work is carried out. Do not reconnect it until the maintenance or repair work has been successfully completed.

The following points should be observed to assist in maintaining quality standards for reprocessing medical devices and sensitive laboratory glassware, and to avoid injury to patients or damage to equipment.

- ▶ If the washer-disinfector is being used for disinfection in accordance with official regulations on the control of epidemics, the steam condenser and its connections to and from the wash cabinet must be cleaned and disinfected whenever any repairs are carried out or parts replaced.
- ▶ If it is necessary to interrupt a programme in exceptional circumstances, this may only be done by authorised personnel.
- ▶ The standard of cleaning and disinfection in the disinfection programmes for medical devices must be routinely confirmed by the user. The process must be validated on a regular basis, and checked against documented control results. Chemical disinfecting procedures must also be validated using chemical or bio indicators.

- ▶ For thermal disinfection, use temperatures and temperature holding times to achieve the required infection prophylaxis in accordance with current health and safety regulations.
- ▶ Medical devices should be reprocessed by thermal disinfection. Items which are not heat-resistant, e.g. operating theatre (OP) shoes, should be cleaned with the CHEM-DISIN programme with the addition of a chemical disinfection agent. The range of effective disinfection is based on claims made by the producer of the disinfecting agent, whose advice regarding handling, use and effectiveness must be observed. This type of chemo-thermal procedure is not suitable for reprocessing medical devices.
- ▶ Chemical agents could, under certain conditions, cause damage to the washer-disinfector. Follow the recommendations of the chemical agent manufacturer. In the event of any damage or material deterioration please contact Miele.
- ▶ Pre-treatments with cleaning or disinfecting agents can create foam, as can certain types of soiling and chemical agents. Foam can have an adverse effect on the disinfection and cleaning result.
- ▶ Foam must not be able to escape from the wash cabinet. It would hinder the correct functioning of the machine.
- ▶ The process used should be checked regularly by the supervisor to monitor foaming levels.

Warning and safety instructions

▶ To avoid the risk of damage to the washer-disinfector and any accessories used with it caused by chemical agents, soiling and any reaction between the two please read the notes in "Chemical Processes and Technology".

▶ Where a chemical agent is recommended on technical application grounds (e.g. a cleaning agent), this does not imply that the manufacturer of the machine accepts liability for the effect of the chemical on the items being cleaned.

Please be aware that changes in formulation, storage conditions etc. which may not be publicised by the chemical manufacturer, can have a negative effect on the cleaning result.

▶ When using cleaning agents and specialised products it is essential that the manufacturer's instructions are followed. Chemicals must only be used for the purpose they are designed for and in the situation specified, to the exclusion of other chemicals, to avoid such dangers as chemical reactions and material damage.

▶ In critical applications where very stringent requirements have to be met, it is strongly recommended that all the relevant factors for the process, such as chemical agents, water quality etc. are discussed with Miele.

▶ If cleaning and rinsing results are subject to particularly stringent requirements (e.g. chemical analysis), a regular quality control test must be carried out by the supervisor to ensure that the required standards of cleanliness are being achieved.

▶ Mobile units, baskets and inserts should only be used for the purpose they are designed for. Hollow instruments must be thoroughly cleaned, internally and externally.

▶ Empty any containers or utensils before arranging them in the machine.

▶ The amount of residual solvents and acids on items going into the cabinet should be minimal. This applies in particular to hydrochloric acid or chloride solutions and to items containing iron that can rust or corrode. The presence in soiling of any solvents should be minimal (especially those in hazard class A1).

▶ Ensure that solutions or steam containing hydrochloric acid do not come into contact with the steel outer casing of the machine, to avoid any corrosion damage.

▶ After carrying out any work on the mains water system, the water supply system to the washer-disinfector must be vented.

Otherwise, components in the machine may become damaged.

Warning and safety instructions

► In areas which may be subject to infestation by cockroaches or other vermin, pay particular attention to keeping the appliance and its surroundings in a clean condition at all times. Any damage which may be caused by cockroaches or other vermin will not be covered by the guarantee.

► Please follow the advice on installation in these instructions and the separate Installation Instructions.

Using accessories

► Only use genuine Miele original accessories with this washer-disinfector and only use them for the purposes they are designed for. Consult Miele on the type and application of such equipment.

► Only use Miele mobile units, baskets and inserts in this machine. Using mobile units, baskets and inserts made by other manufacturers, or making modifications to Miele accessories, can result in unsatisfactory cleaning and disinfecting results, for which Miele cannot be held liable. Any resultant damage would also invalidate the machine guarantee.

► Only use chemical agents which have been approved by their manufacturer for use in the application you are using. The chemical agent manufacturer is responsible for any negative influences on the material the load is made from and for any damage they may cause to the machine.

Symbols on the appliance



Warning:
Observe the operating instructions.



Warning:
Danger of electric shock.

Disposing of your old machine

► Please note that the machine may have contamination from blood or other bodily fluids in it and must be decontaminated before disposal. For environmental and safety reasons ensure the machine is completely drained of any residual water, chemical residues and cleaning agent. Observe safety regulations and wear safety goggles and gloves. Make the door lock inoperable, so that children cannot accidentally shut themselves in. Then make appropriate arrangements for its safe disposal. For tank system machines ensure that any water is emptied out of the tank.

The manufacturer cannot be held liable for damage caused by non-compliance with these Warning and Safety instructions.

Intended Use

Re-usable medical devices, laboratory equipment and accessories can be cleaned, rinsed, disinfected and dried in this Miele washer-disinfector. Follow the medical device and laboratory equipment manufacturer's instructions (according to EN ISO 17664) and local and national regulations and guidelines, on how to reprocess their items by machine.

Examples of application areas:

- surgical instruments,
 - minimally invasive surgical instruments,
 - anaesthetic and intensive care instruments,
 - baby bottles and teats,
 - operating theatre shoes,
- or
- laboratory equipment used in research and development,
 - laboratory equipment used in areas of analysis and specimen taking,
 - laboratory equipment used in micro-biology and biotechnology.

The type of laboratory equipment which can be reprocessed ranges from evaporating dishes to centrifugal test tubes.

Reprocessing medical devices and laboratory equipment by machine achieves reproducible results, and should be used in preference to reprocessing them by hand.

Where disinfection is required for the protection of staff and/or patients, carry out thermal disinfection using e.g. the DESIN vario TD programme.

- Except for operating theatre (OP) shoes which are not heat-resistant, for which the CHEM-DISIN programme should be used.

The parameters for thermal disinfection according to EN ISO 15883-1 (A_0 concept) vary depending on the disinfection standard required. They are 80 °C (+ 5 °C, - 0 °C) with a 10 min holding time (A_0 600) or 90 °C (+ 5 °C, - 0 °C) with a 5 min holding time (A_0 3000). An A_0 value of 3000 is suitable for deactivating the HBV virus.

National health and safety regulations regarding disinfection must also be observed (CfPP 01-01, Part D and Harmonised EU Norm EN 15883-2 in the UK).

The cleaning programme as well as any chemical agents must be chosen according to the type of soiling and load being processed.

The agents used for reprocessing the products should be selected to suit the level of cleaning required as well as the method of analysis used.

The cleaning result must ensure that instruments can be disinfected correctly, that no residues are left behind, that subsequent sterilisation can be carried out and that the instruments can be used again safely. Medical devices are best reprocessed using the DESIN vario TD programme, or the ORTHOVARIO or OXIVARIO programme where applicable.

The use of a suitable carrier (mobile unit, module, insert etc.) is important to ensure the adequate cleaning of the load. Examples are given in the section "Areas of application".

The washer-disinfector is programmed to carry out the final rinse with mains water or with processed water of a quality to suit the application (e.g. aqua destillata, purified water, de-ionised water, demineralised water). The water quality is of particular importance for applications requiring analytically clean laboratory glassware.

This washer-disinfector complies with EN ISO 15883 for validation purposes.

User profile

Daily operatives

Operatives using the machine daily should be familiar with the basic functions of the machine and its loads and trained on a regular basis. They require basic knowledge about how to reprocess medical devices by machine.

Generally they would be using the machine in Operating levels A and C.

Supervisory level

More advanced functions such as interrupting or cancelling a programme requires more in-depth knowledge about machine reprocessing of medical devices.

This level of functionality is carried out in Operating level B.

Service and Administration

Changes to processing methods and alterations to the washer-disinfector, e.g. concerning the type of accessories used in it or the conditions in which the machine is used requires additional knowledge about the machine.

Validation also requires additional knowledge about how to reprocess medical devices, which procedure to use and any Standards and regulations that may apply.

Service and validation work is carried out using Operating level D.

Description of the machine

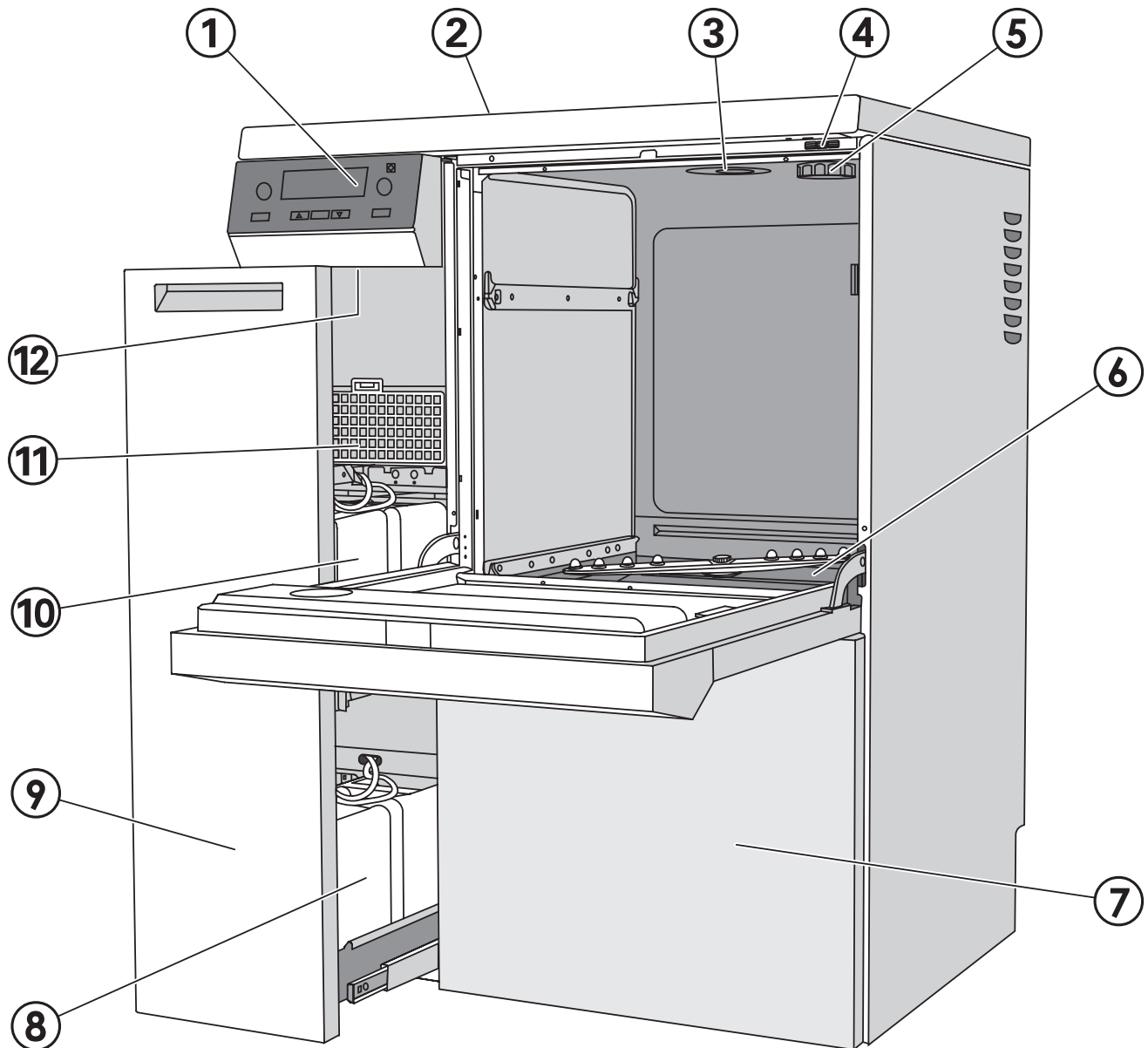

- ① Electronic controls
- ② Serial interface,
at the back of the machine
(top left behind the cover panel)
- ③ Water inlet
- ④ Test point for validation
- ⑤ Salt reservoir connection point
(for the water softener)
- ⑥ Filter combination
- ⑦ Service panel
- ⑧ Containers for dispensing systems
DOS 2 and DOS 4 (optional)
- ⑨ DOS drawer
- ⑩ Reservoir for neutralising agent (red)
and liquid cleaning agent (blue)
- ⑪ Drying unit (TA)
- ⑫ Reset button

Description of the machine

Controls

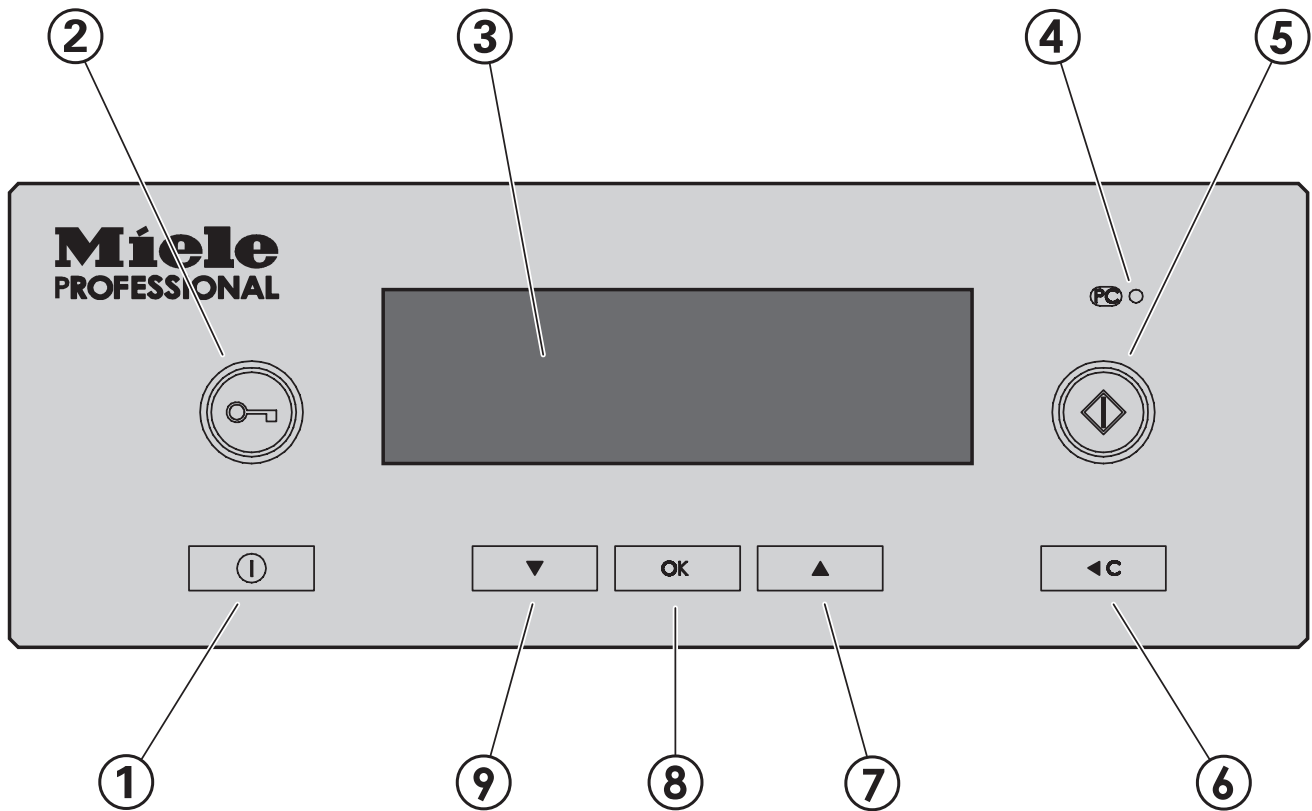

① On/Off button 

For switching the machine on and off

② Door button 

③ Display

The display will switch off automatically after approximately 10 minutes when the washer-disinfector is not in operation.

Press any button to switch the display back on again.

Faults occurring during operation will be indicated by a number in the display.
The fault numbers are listed in the Programming manual.

Description of the machine

- ④ **PC service interface** (PCO)
For testing and updating the programme data
- ⑤ ◀ **Start button**
For starting the programme
- ⑥ **◀C (Clear) button** used to
 - return to the previous level
 - delete entries already made
 - to cancel a programme
- ⑦ and ⑨ **▲ ▼ buttons (Selector buttons)** used to
 - move the highlighting in the display
 - change highlighted values
 - scroll
 - call up context menus
 - show user defined operating parameters during the programme
- ⑧ **OK button**
 - confirm highlighted options or selected values
 - acknowledge error messages
 - acknowledge dialogue messages
 - call up the A_0 graph during a programme.
 - view the temperature graph during a programme.

Display

The display can show the following, depending on the operating level:

- the programme / programme overview
- the programming menu
- the Settings  menu

The **Settings** menu  is used to alter the washer-disinfector's profitronic controls to suit different requirements. See the Programming manual for more details.

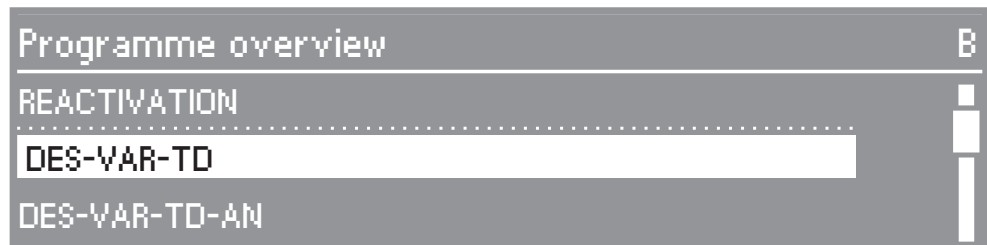

An example of a selected list





The   buttons are used to select the options.

The selector buttons   move the highlighting in the display.

The **OK** button is used to confirm a message or setting and also to move to the next menu or to another menu level.

To select an option use the selector buttons   to highlight it and then confirm your selection with the **OK** button.

The display shows a maximum of three options or choices. A scroll bar on the right hand side of the display indicates that more options or choices are available. The   selector buttons are used to display these.

The end of the list is marked with a dotted line. The last entry in the list is shown above the line and the first, below it.

Description of the machine

An example of a programme sequence display



During a programme, the display shows the following:

- the name of the programme
- the operating level
- the programme block
- the water temperature
(the air temperature in the "Drying" programme block)
- the estimated programme duration remaining or the programme duration already elapsed
- any relevant error messages and notes.

Some functions can be called up at any time via a context menu, irrespective of the operating level:

- Change display language,
- Change operating level,
- Enter delay start,

In addition, no current fault messages will be displayed in operating level D (if applicable).

- Press the ▲▼ buttons at the same time for at least 3 seconds to call up the context menu.

The context menu will appear in the display:



The ▲▼ buttons are used to select the options.

Context menu

Change display language

You can change the language in which the display is currently being shown via the context menu. This setting will remain active until the washer-extractor is switched off with the Ⓛ button.

N.B. The language set in the Settings / Language 🚩 menu will not be changed and all reports and print-outs will continue to be printed in this "Settings" language.

- Select the **Change display language** option with ▲ ▼ and activate your selection with **OK**.

The flag 🚩 after the words **Change display language** acts as a guide if a language which you do not understand has already been set. If this is the case, keep changing the options until the flag 🚩 appears.

- Select the language you require and confirm your selection with **OK**.

The language selected will be shown in the display.

- Press ◀C to come out of the context menu.

Changing operating level



There are four operating levels available on this washer-disinfector:

Operating level	Access authorisation for
A and B	Selection from a list of specified programmes.
C	Automatic programme selection via mobile unit coding.
D	Free programme selection in the Programme overview, Programming and Settings  .

You can switch between the operating levels via the context menu.

To prevent unauthorised access to the settings, you will be asked for a code when changing to another operating level.

You must be signed on as the administrator, to be able to change the codes of the various operators or to install new operators. The **Administrator** operator is set by a Miele Service technician.

- Press the   buttons at the same time for at least 3 seconds.

The context menu will appear in the display:

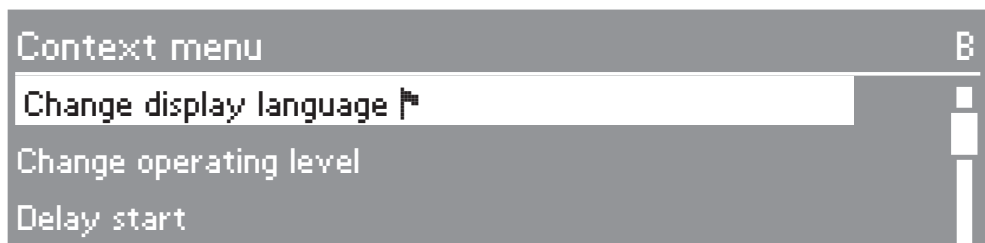

Context menu

- Select the **Change operating level** option and call up the sub-menu with **OK**.



- Select the user group you require and confirm with **OK**.
- Enter the requested code.

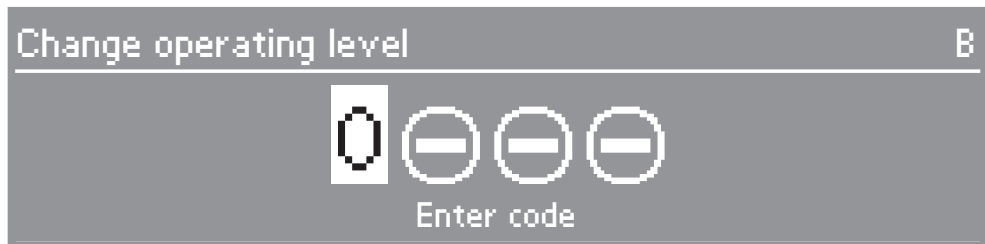

The ▲▼ buttons alter the values, the **OK** button confirms the values entered and moves on to the next input position.

The electronics will change to the operating level selected.

- Press ◀**C** to come out of the context menu.

Code invalid will appear if you make a wrong entry.

- Acknowledge the fault message with **OK**.

The Change operating level process will begin again.

Delay start

Please read "Area of application / Surgical instruments" for instructions about using Delay Start with surgical instruments.

A programme can be set to start at a later, specific time.

- To do this, highlight the **Delay start** option and confirm your selection.
- To activate Delay start, select **Yes** for the **Activate** option.

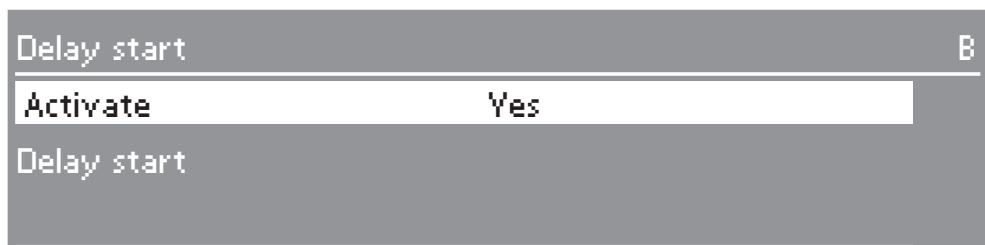

- To set the Delay start time, highlight the **Delay start** parameter and confirm your selection.

The menu for entering the start time will appear.



- Enter the start time, digit by digit and confirm your entry.
- Press the **◀C** button repeatedly until **Programme overview** appears in the display.



- Select a programme and press **◊** to start it.

Context menu

The selected programme, the start time set, the current time of day and time remaining until the start of the programme will appear in the display.



The programme selected will now start automatically when the start time is reached.

The automatic start time for the programme can be cancelled.

- Press the **◀C** button.

You will be asked to double check your decision:



- To cancel the programme start time, select **Yes** and confirm your selection.
- The automatic start time for the programme is now cancelled. The display will change back to the Programme overview. The **Delay start** function is deactivated. If you select **No** the delay start time for the programme will continue to count down.
- The **Delay start** function is deactivated automatically at the end of the programme.
- You can also deactivate the **Delay start** function without actually starting the programme (starting the count down to the start time). To do this, set the **Activate** parameter in the **Delay start** menu to **No**.

Current faults

The Current faults option is displayed in Operating level D if there has been at least one fault at that point in time.

The current fault messages can be called up in operator level **D** using this option.

- Select the option and confirm your selection with **OK**.

Any faults which are present at the moment will be displayed.

- Use **OK** to change between the fault messages.
- Press **◀C** to come out of the context menu.

Reactivation

This option is only visible in Operating level **C** when a programme is not running.

All other procedures in connection with the water softener are described in the section "Water softener".

Opening and closing the door

Electric door lock

This washer-disinfector is equipped with an electric door lock.

The door can only be opened when:

- the electricity supply to the machine is switched on,
- the machine has been switched on using the ① button and
- a cleaning or disinfection programme is not in progress.

To open the door

- Press the  button, and holding onto the door grip open the door.

 Do not touch the heating elements if you open the door directly after the end of a programme: you could burn yourself. They remain hot for some time after the end of the programme.

To close the door

- Lift the door upwards and push until it clicks shut.

To open the door with the emergency release

 The emergency release should only be used when the door cannot be opened normally, e.g. in the event of a power failure. Be especially careful when using DESIN programmes - read the notes in the Warning and Safety instructions carefully.

 If the door is opened using the emergency release cord, there is a danger of burning, scalding and chemical burning or, if a disinfecting agent has been used, inhalation of toxic fumes.

Do not touch the heating elements when opening the door during a programme - you could burn yourself.

- Disconnect the machine from the mains electricity supply.

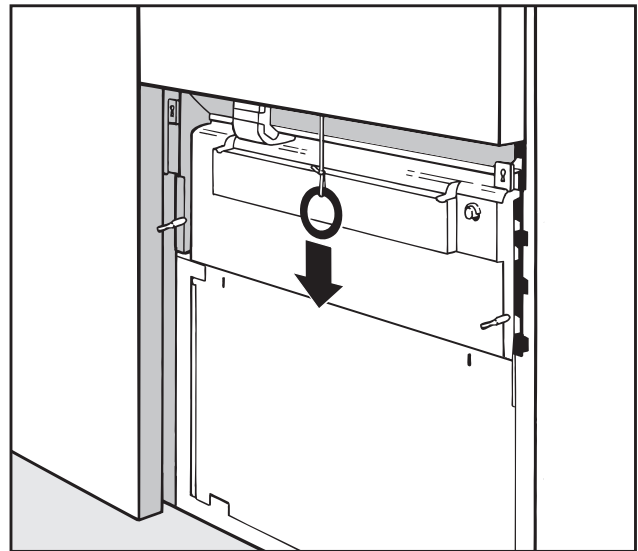

- The emergency release cable is located at the bottom of the machine behind the service panel. Pull it downwards to open the door.

 If a great deal of hot water is present in the wash cabinet when the emergency release cord is operated and the door is then closed quickly, hot water can escape. Danger of burning or scalding.

In order to achieve good cleaning results, the washer-disinfector needs to operate with soft water. Hard water results in the build-up of calcium deposits on the load and inside the wash cabinet.

Mains water with a hardness level higher than 0.7 mmol/l (4° dH – German scale) needs to be softened. This takes place automatically in the integrated water softener.

- The water softener requires reactivation salt.
- The washer-disinfector must be programmed to correspond to the water hardness in your area.
- Your local water authority will be able to advise you on the water hardness in your area.

The water softener unit is set at the factory for a water hardness level of 3.4 mmol/l (19 °dH).

If your water hardness differs from this (even if it is below 0.7 mmol/l or 4 °dH) you will need to programme the level into your machine.

Where the water hardness level fluctuates, e.g. 1.4 - 3.1 mmol/l (8 - 17 °dH), set the water softener to the highest setting (3.1 mmol/l (17 °dH) in this example).

The built-in water softener has settings from 1 °dH - 60 °dH (0.2 - 10.8 mmol/l).

For future servicing it is useful to make a note of your water hardness level.

Enter your water hardness level here:

_____ °dH / mmol

Setting the water softener

When the machine is first commissioned the Miele service technician has to set the machine for your local water hardness level (see Programme manual, Operation/Reactivation).

Reactivation display

After a certain number of cycles the message **Reactivation** will appear in the display to warn you that the water softener is depleted and cannot supply any more softened water. **As soon as** the programme has finished **reactivation salt** will need to be replenished.

If this cannot be done immediately, and further cleaning cycles have been carried out, the reactivation process will need to be carried out twice in succession.

Water softener

Reactivating the water softener

Please only use special coarse grained reactivation salt with granules of approx. 1-4 mm. Do not use other types of salt, e.g. table salt, agricultural or gritting salt. These may contain insoluble additives which can impair the functioning of the water softener. If in doubt consult the Miele Professional Department.

The salt reservoir holds approx. 2 kg of salt.

If only fine grained reactivation salt is available please consult the MIELE Professional Sales office for advice.

Salt with granules larger than 4 mm must not be used in this machine.

 Inadvertently filling the salt reservoir with cleaning agent can cause serious damage to the water softener and block the filter insert resulting in a build up of pressure inside the salt container. To avoid the risk of injury please exercise caution when removing the salt reservoir as there may be irritant alkaline solutions present. Before filling the salt reservoir make sure that you have picked up the right packet of reactivation salt.

Filling the salt container

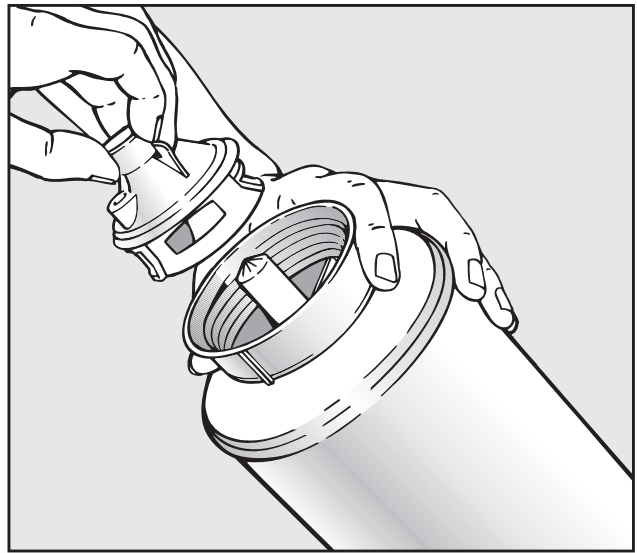

- Unscrew the filter insert from the salt container and remove.
- Fill the salt container with reactivation salt and screw the filter insert back in place.

Position the salt container as follows

- Remove any mobile units from the cabinet.

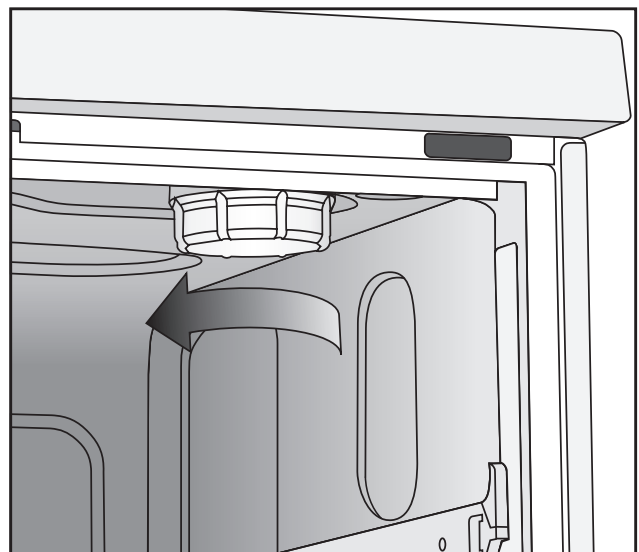

- Unscrew the plastic cap situated in the top right-hand side of the cabinet.

⚠ There will be a small amount of residual water in the cap. Take care as it may be hot from the previous programme.

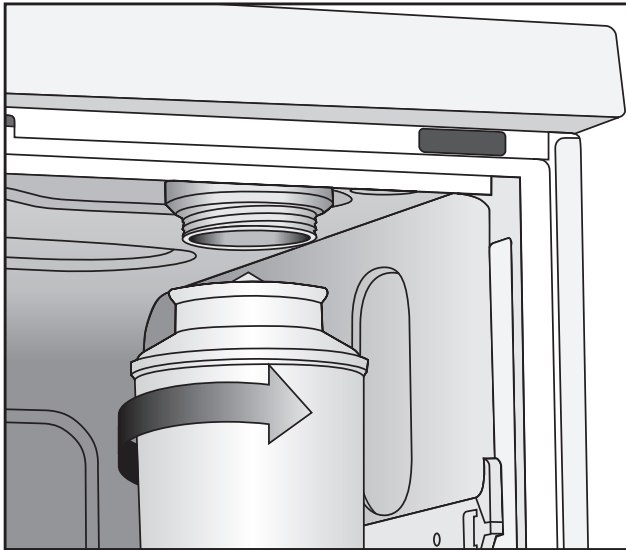

- Screw the salt container firmly onto the socket.

Run the reactivation programme

- Close the door.
- Select and start the **REACTIVATION** programme.

In Operating level **C** reactivation is started using the context menu. To do this:

- Open the context menu.
- Select the **REACTIVATION** option and confirm your selection with **OK**.

The reactivation process will run automatically.

The water pressure (flow pressure at the take off point) must be at least 150 kPa.

If it is below 150 kPa or if it fluctuates a lot, the water softener will not work properly. There could be residual salt in the container after reactivation has taken place.

To use up the remaining salt and to flush out the softener the **REACTIVATION** process must be repeated.

Then:

- Switch the washer disinfecter off.
- Open the door.
- Carefully unscrew the salt container, making sure any water pressure still remaining can depressurise. Do not use force!
If the container will not come off manually please contact the Miele Service Department.
- Empty the salt container. Do not empty it into the wash cabinet.

Saline solution and salt granules in the cabinet can lead to corrosion. It is important they are flushed out immediately and not left in the cabinet.

- Replace the cap to the softener unit.
- Push the mobile unit back into the cabinet.
- Rinse the salt container and filter insert with clean water.

Automatic mobile unit recognition

The automatic mobile unit recognition system allocates a programme to a mobile unit. The mobile units must be coded with a magnetic strip (via a Bit combination).

Magnetic strip ML/2 is available to purchase as an optional accessory.

The programme allocated for a coded mobile unit is available in operating level C.

After a coded mobile unit has been put into the machine and the door closed, the automatic mobile unit recognition system will select the allocated programme.

The coding of the mobile units and the allocation of programmes in the electronic control unit are described in the Programming manual for the washer-disinfector.

 Make sure that there are no small metallic objects or instrument parts attracted to the magnetic strip, in particular to the underside of it. Any metallic objects on the strip can result in the coding being incorrectly read.

Magnetic strips for the PG 8535 / PG 8536 must have **grey** magnets.

Spray arm monitoring

Cleaning and disinfecting results depend on all surfaces and hollow areas of the load being accessible by the wash liquor.

Wash liquor is distributed throughout the cabinet by an upper and a lower spray arm.

When activated, **Spray arm monitoring** checks whether the spray arms are rotating within their lower and maximum range.

Mobile unit

Mobile units may be fitted with one or more spray arms.

These need to be fitted with magnets for spray arm monitoring.

 Mobile unit spray arm monitoring can only function if the mobile unit is fitted with a coded magnetic strip (see "Mobile unit coding").

Upper and lower baskets

The PG 8535 and PG 8536 washer-disinfectors can also be fitted with an upper or lower basket in addition to the mobile unit.

The upper basket can also be fitted with spray arms. These can also be monitored. This does not require a magnetic strip.

The machine is supplied with spray arm monitoring switched off for the upper basket.

If upper baskets without spray arms are always used this setting can be left unchanged.

If upper baskets with and without spray arms are used, and spray arm monitoring is active, the following question will be asked before starting the programme:

Basket with one spray arm?

Answer **Yes** or **No**.

This question can be deactivated by Miele Service if you only ever use upper baskets with one spray arm.

Laboratory applications

For narrow-necked utensils, e.g. narrow-necked conical flasks, round bottomed flasks, measuring flasks and pipettes, a mobile injector unit or injector basket is required.

Spray arm monitoring for the upper spray arm in the cabinet is only used in some instances with laboratory applications.

Upper basket	Lower basket	Spray arm monitoring
O 175	U 175/1	yes
O 175	U 184/1	yes
O 184	U 175/1	no
O 184	U 184/1	no
O 187	U 175/1	yes
O 187	U 184/1	yes

Areas of application

This washer-disinfector can be fitted with a variety of mobile units, which can be equipped with a variety of modules and inserts depending on the type and shape of items requiring cleaning and disinfection.

Select mobile units, baskets and inserts which are appropriate for the application.

Notes on the individual areas of application and examples of loading are given on the following pages.

Before starting a programme you should carry out a visual check on the following:

- Is everything correctly loaded/connected for cleaning?
- Are the spray arms clean and do they rotate freely?
- Are the filters clean? Remove any coarse soiling and clean them properly if necessary.
- Is the adapter connecting the water supply to the spray arms/jets correctly connected?
- Are all chemical containers sufficiently filled?

At the end of each programme:

- Carry out a visual check of the load for cleanliness.
- Check that all hollow shafted instruments are still securely located on their jets.

 Any hollow instruments that have become disconnected from their adapters during reprocessing must be reprocessed again.

- Check that the lumen of hollow instruments are free of obstruction.
- Check that jets and connectors are securely held in position in the baskets or inserts.

Protein test

Cleaning results should be subjected to periodic protein tests, e.g. with the Miele test kit.

Loading the machine

- Arrange the load so that water can access all surfaces. This ensures that it gets properly cleaned.
- Do not place items to be cleaned inside other pieces where they may be concealed.
- Hollow instruments must be thoroughly cleaned, internally and externally.
- Ensure that instruments with long narrow hollow sections can be flushed through properly before placing them in inserts or connecting them to jets.
- Hollow vessels should be inverted and placed in the correct mobile units, modules and inserts to ensure that water can flow in and out of them unrestricted.
A cover net can be used to reduce the risk of glass breakage during the wash process.
- Lightweight items should be secured with a cover net (e.g. an A 6) and small items placed in a mesh tray to prevent them blocking the spray arms or being attracted by the magnetic strip on the automatic mobile unit recognition system.
- Deep-sided items should be placed at an angle to make sure water runs off them freely.
- Tall, narrow pieces should be placed in the centre of the baskets. This ensures good water coverage.
- Mobile units with an adapter must engage correctly.

- Modules must be correctly connected in the mobile unit.
- The spray arms must not be blocked by items which are too tall or which hang down in their path. If in doubt, test for free movement by manually rotating the spray arms.
- It is advisable to use only instruments made of special application steel which are not susceptible to corrosion.
- Instruments which cannot withstand high temperatures should be chemically disinfected.

 Disposable instruments must not be put into the machine for reprocessing.

The loading pattern as specified in the validation procedure must be meticulously maintained.

Preparing the load

Empty all containers before loading into the machine (paying particular attention to regulations regarding infectious diseases and epidemics).

 Ensure that acids and residual solvents, especially hydrochloric acid or chlorides, cannot get into the wash cabinet.

Unloading instruments

Instruments should be unloaded dry ready for further processing.

Areas of application

Water connection spring adapter

Make sure that the water connection spring adapter engages correctly when a basket or injector unit is inserted in the machine. It must be 4-5 mm higher than the water connection inlet in the machine. If it is not:

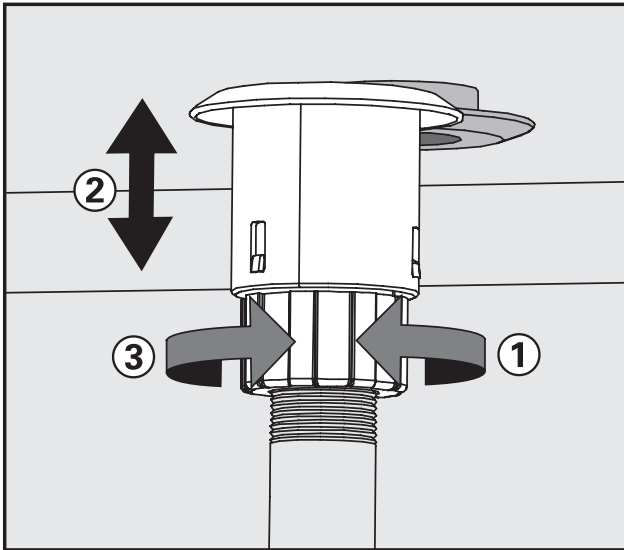

- Loosen lock ring ①.
- Push up adapter ②.
- Tighten lock ring ③.

Height adjustable top basket

The top basket can be adjusted above and below the middle position by 2 cm.

Different height items can be reprocessed in this machine depending on the position the top basket is set at, and the inserts used in the baskets / mobile units.

The height available in the right hand side of the top basket is limited by the salt reservoir connection point.

To adjust the top basket:

- Pull out the top basket until a resistance is felt; lift from the runners and remove.
- Unscrew the roller bearings on both sides of the basket with a 7 mm spanner and reposition as required.

Surgical instruments (OP)

Surgical instruments should be stored for as short a time as possible before machine reprocessing - and for no longer than 2 hours.

The OXIVARIO or ORTHOVARIO processes should be used for instruments where there is a long delay between the time they are used and the time they can be reprocessed. See "Special processes" at the end of this booklet.

Disinfection of surgical instruments and of those used for minimal invasive surgery should take place thermally.

De-ionised water should be used for the final rinse whenever possible to ensure no marks are left on the load and to avoid corrosion. If the water used contains more than 100 mg chloride/litre there is danger of corrosion.

Open up hinged instruments and place them in mesh trays so that they are not touching each other.

Mobile units for surgical instruments are supplied with their own operating instructions.

When reprocessing **narrow lumen instruments e.g. those used for minimally invasive surgery**, an intensive internal cleaning result is imperative. The **Vario-TD** and **OXIVARIO** (special kit required) programmes are the only ones which offer a thorough enough level of cleaning for this. It is essential that instruments are loaded as directed and that the cleaning agent used is suitable for the programme and for the sensitive instruments being reprocessed. The final rinse must be carried out using fully demineralised water with a conductivity level of $\sim 15 \mu\text{S}/\text{cm}$ (microsiemens per centimeter).

Instruments with very narrow lumen must be manually pre-rinsed where necessary. Follow the instrument manufacturer's instructions on how to handle them.

Areas of application

Ophthalmology

Ophthalmic instruments should be cleaned and disinfected in a special mobile injector unit.

The final rinse should be carried out using demineralised water with a conductivity of $\sim 15 \mu\text{S}/\text{cm}$ (Microsiemens per centimetre). In terms of quality, the water used for the final rinse must contain minimal amounts of endotoxins and pyrogens.

The top level is fitted with various connections for hollow instruments, e.g. rinsing and suction hand pieces, and cannulae.

Instruments are secured to the hose connectors in the mobile injector unit using the silicone holders and connectors in the rack.

The lower level of the mobile injector unit is designed to take E 441/1 inserts or E 142 mesh trays for reprocessing solid instruments.

 Plastic fibre cover nets must not be used in washer-disinfectors which are used to reprocess hollow ophthalmic instruments with narrow lumen.

The mobile injector unit for ophthalmic instruments is supplied with its own operating instructions.

Anaesthetic instruments (AN)

Anaesthetic instruments should be thermally disinfected using the DES-VAR-TD-AN programme.

If the process is not to be followed by sterilisation, the load should be dried completely to avoid the development of water-borne bacteria.

A sufficient drying time is, therefore, absolutely essential.

Mobile units for anaesthetic instruments are supplied with their own operating instructions.

Areas of application

Baby bottles (BC)

Baby bottles can be reprocessed in E 135 containers, wide-necked teats in an E 364 insert and screw connection teats in an E 458 insert.

- Ensure the level marker on the bottles is dishwasher proof.
- If there is a delay of 4 hours or more before bottles can be washed, fill them with water to prevent residues from drying on.

If the process is not to be followed by sterilisation, the load should be dried completely to avoid the development of water-borne bacteria.
A sufficient drying time is, therefore, absolutely essential.

Inserts for baby bottles and teats are supplied with their own operating instructions.

Operating theatre shoes

OP shoes made of thermolabile material and/or insoles can be cleaned and disinfected chemo-thermally at 60 °C with the CHEM-DISIN programme.

A thermal disinfection process (SHOE-TD programme) can be used if thermostability has been confirmed by the manufacturer.

To establish the effectiveness of chemical disinfecting agents for chemo-thermal disinfection, consult the manufacturer.

Theatre (OP) shoes should only be cleaned and disinfected in a machine installed specifically for this purpose.

A risk evaluation should be carried out by the user when using other applications in addition to the preparation of OP (Theatre) shoes in the washer-disinfector.

The following baskets can be used:

- O 167 for theatre shoes up to size 40,
- O 173 for theatre shoes up to size 41, and
- U 168/1 for theatre shoes up to size 45 .

Alternatively insert E 484 can be used in a suitable bottom basket, e. g. U 874 together with holder E 487 for shoes or E 489 for insoles.

A large amount of fluff can build up in the machine when cleaning theatre shoes. The filters in the wash cabinet should be checked regularly and cleaned when necessary. See "Maintenance, Cleaning the filters in the wash cabinet".

Areas of application

Laboratory glassware (LG)

Wide-necked laboratory glassware, e.g. beakers, wide-necked Erlenmeyer flasks and Petri dishes, and cylindrical shaped items e.g. test tubes, can be cleaned and rinsed, internally and externally, by the action of the rotating spray arms. They can be arranged in full, half and quarter inserts in an empty lower or upper basket with spray arms. Narrow-necked items e.g. narrow-necked Erlenmeyer flasks, conical flasks, measuring flasks and pipettes, require mobile injector units or injector modules.

The following instructions relate only to basic preparation and loading of laboratory utensils.

Loading the machine

Preparing the load

- Empty all glassware before loading into the machine (paying particular attention to regulations regarding epidemics).

 Ensure that acids and residual solvents, especially hydrochloric acid or chlorides, cannot get into the wash cabinet.

- Remove all agar residues from Petri dishes.
- Remove blood clots and residues from test tubes, etc.
- Remove all stoppers, corks, labels, sealing wax residues, etc.
- Small parts - such as stoppers and taps - should be secured in suitable basket inserts.

Please note

- Petri dishes and similar should be placed in the correct insert with the soiled side facing the central axis.
- Pipettes should be placed with the mouthpiece facing upwards.
- Quarter inserts should be placed in the mobile unit with at least 3 cm between them and the edge of the mobile unit.

Areas of application

Programme	Areas of application
LAB-STANDARD	Simple, short programme for items with slight soiling and which have low final rinse result requirements: <ul style="list-style-type: none"> – for various types of soiling, – not suitable for denaturing residues such as protein, – not suitable for acid soluble residues such as metallic salts and amines.
LAB-UNIVERSAL *	General programme for items with slight to medium-heavy soiling which have medium final rinse result requirements: <ul style="list-style-type: none"> – for removing organic residues, e.g. protein, some oils and fats, – suitable for inorganic residues, e.g. pH 7 water soluble metallic salts, – for preparation areas and for analysis.
LAB-INTENSIVE *	Programme for items with medium-heavy to heavy soiling which have medium to high final rinse result requirements: <ul style="list-style-type: none"> – for removing organic residues, e.g. protein, cell and tissue cultures, some oils and fats, – suitable for inorganic residues, e.g. pH 7 water soluble metallic salts, – for preparation areas and for analysis.
LAB-PIPETTES	General programme for items with slight to medium-heavy soiling which have medium to high final rinse result requirements: <ul style="list-style-type: none"> – for pipettes.
PLASTIC	Programme for items with slight to medium-heavy soiling which have medium final rinse result requirements: <ul style="list-style-type: none"> – for temperature-sensitive laboratory equipment, e.g. plastic bottles which can withstand temperatures of at least 55 °C, – for preparation areas, – suitable for some analysis.
ORGANIC *	Programme for items with medium-heavy to heavy soiling which have medium final rinse result requirements: <ul style="list-style-type: none"> – for removing organic residues, e.g. oil, fat, wax and agar, – not suitable for acid soluble residues such as, for example, metallic salts and amines.
INORGANIC	Programme for items with slight to medium-heavy soiling which have medium to high final rinse result requirements: <ul style="list-style-type: none"> – for removing inorganic residues, – for analysis and water analysis, – for aqueous culture media with acid soluble metallic salts such as Ca²⁺, Mg²⁺ etc.
LAB-OIL *, **	Programme for items with heavy soiling which have medium final rinse result requirements: <ul style="list-style-type: none"> – for removing oil soiling, e.g. crude oil, synthetic oil and lubricants, motor fuel and semi-natural oils, – not suitable for acid soluble residues such as, for example, metallic salts and amines.

* For organic residues such as oil and fat we recommend refitting the washer-disinfector with oil and fat resistant elastomers.

** Dispensing system DOS NA 120 is also required.

Chemical processes and technology

General notes	
Problem	How to resolve it
<p>If seals, hoses and plastics in the washer-disinfector suffer damage they will not be water-tight and will not function correctly.</p>	<ul style="list-style-type: none">– Establish the cause of the damage and rectify it. <p>See information regarding "Chemical agents", "Soiling" and "Reaction between chemical agents and soiling".</p>
<p>Heavy foaming during a programme affects cleaning and rinsing results. Foam escaping from the wash cabinet can cause damage to the washer-disinfector. Cleaning processes cannot be regulated and validated where there has been a build-up of foam.</p>	<ul style="list-style-type: none">– Establish the cause of the foam and rectify it.– Check the process used regularly to monitor foaming levels. <p>See information regarding "Chemical agents", "Soiling" and "Reaction between chemical agents and soiling".</p>
<p>Corrosion to stainless steel in the wash cabinet and to accessories can give them a different appearance:</p> <ul style="list-style-type: none">– Rust (red marks / discolouration),– black marks / discolouration,– white marks / discolouration (etched surface). <p>Corrosive pitting can lead to the washer-disinfector not being water-tight. Depending on application corrosion can influence cleaning and rinsing results (laboratory analysis) or cause corrosion to stainless steel items in the cabinet.</p>	<ul style="list-style-type: none">– Establish the cause of the corrosion and rectify it. <p>See information regarding "Chemical agents", "Soiling" and "Reaction between chemical agents and soiling".</p>

Chemical processes and technology

Chemical agents	
Problem	How to resolve it
<p>The ingredients in chemical agents have a strong influence on the longevity and functionality (throughput) of the dispensing system. The dispensing system (hoses and pumps) should be set up for a particular type of chemical agent.</p> <p>General types:</p> <ul style="list-style-type: none"> – alkaline to pH neutral products, – acidic to pH neutral products, – hydrogen peroxide. 	<ul style="list-style-type: none"> – Observe the chemical agent manufacturer's instructions and recommendations. – Carry out a regular visual check of the dispensing system for any damage. – Regularly check the flow rate of the dispensing system.
<p>Chemical agents can damage elastomers and plastics in the washer-disinfector and accessories.</p>	<ul style="list-style-type: none"> – Observe the chemical agent manufacturer's instructions and recommendations. – Carry out a regular visual check of any accessible elastomers and plastics for damage.
<p>Hydrogen peroxide can release large quantities of oxygen.</p>	<ul style="list-style-type: none"> – Only use approved processes such as OXIVARIO or OXIVARIO PLUS. – The wash temperature must be less than 70 °C when using hydrogen peroxide. – Please contact Miele for advice.
<p>The following chemical agents can cause large amounts of foam to build up:</p> <ul style="list-style-type: none"> – cleaning agents and rinsing agents containing tensides. <p>Foam can occur:</p> <ul style="list-style-type: none"> – in the programme block in which the chemical agent is dispensed, – in the following programme block if it has been spilt, – in the following programme with rinsing agent if it has been spilt. 	<ul style="list-style-type: none"> – Process parameters in the wash programme, such as dispensing temperature, dosage concentration etc. must be set to ensure the whole process is foam free or very low foaming. – Please observe the chemical agent manufacturer's instructions.

Chemical processes and technology

Chemical agents

Problem

De-foaming agents, especially silicone based ones can cause the following:

- deposits to build up in the cabinet,
- deposits to build up on the load,
- damage to elastomers and plastics in the washer-disinfector,
- damage to certain plastics (e.g. polycarbonate and plexiglass) in the load being reprocessed.

How to resolve it

- De-foaming agents should be used in exceptional cases only, for instance when absolutely essential for the process.
- The wash cabinet and accessories should be periodically cleaned without a load and without de-foaming agent using the ORGANIC programme.
- Please contact Miele for advice.

Soiling

Problem

The following substances can damage elastomers (hoses and seals) and plastics in the washer-disinfector:

- oil, wax, aromatic and unsaturated hydrocarbons,
- emollients,
- cosmetics, hygiene and care products such as creams (analytical applications).

How to resolve it

- Refit the washer-disinfector with oil resistant elastomers.
- Depending on usage wipe the lower door seal on the washer-disinfector periodically with a lint-free cloth or sponge.
Clean the wash cabinet and accessories without a load using the ORGANIC programme.
- Prepare the load using the "OIL" programme (where this is available) or use a special programme that dispenses cleaning agents containing tensides.

Chemical processes and technology

Soiling	
Problem	How to resolve it
<p>The following substances can lead to a heavy build-up of foam during washing and rinsing:</p> <ul style="list-style-type: none">– some disinfecting agents and dishwashing detergents,– reagents for analysis e.g. for microtiter plates,– cosmetics, hygiene and care products such as shampoos and creams (analytical applications),– active foaming agents such as tensides.	<ul style="list-style-type: none">– Thoroughly rinse items in water beforehand.– Select a cleaning programme with at least one short pre-rinse in cold or hot water.– Depending on application use de-foaming agents that do not contain silicone oils.
<p>The following substances cause corrosion to stainless steel in the wash cabinet and on accessories:</p> <ul style="list-style-type: none">– hydrochloric acid,– other substances containing chlorides such as sodium chloride etc.,– concentrated sulphuric acid,– chromic acid,– particles of iron and swarf.	<ul style="list-style-type: none">– Thoroughly rinse items in water beforehand.– Place items drip dried into mobile units, baskets and inserts and then place these in the wash cabinet.

Chemical processes and technology

Reaction between chemical agents and soiling	
Problem	How to resolve it
Natural oils and fats can be emulsified with alkaline chemical agents. This can lead to a heavy build-up of foam.	<ul style="list-style-type: none">– Where available use the "OIL" programme.– This special programme dispenses cleaning agents containing tensides (pH neutral) in the pre-rinse.– Depending on application use de-foaming agents that do not contain silicone oils.
Soiling containing high protein levels such as blood can cause a heavy build-up of foam when processed with alkaline chemical agents.	<ul style="list-style-type: none">– Select a cleaning programme with at least one short pre-rinse in cold water.
Non-precious metals such aluminium, magnesium and zinc can release hydrogen when processed with very acidic or alkaline chemical agents (oxyhydrogen reaction).	<ul style="list-style-type: none">– Please observe the chemical agent manufacturer's instructions.

Dispensing liquid chemical agents

 Only use chemical agents designed specifically for use in washer-disinfectors and follow the manufacturer's instructions on their application. Please observe carefully any instructions relating to toxic residues.

The washer-disinfector can be fitted with a maximum of four internal dispensing systems. They are colour-coded to ensure that the dispenser pumps are attached to the correct siphon tubes.

Dispensing system	Colour code
1	blue
2	white
3	red
4	green

The correct amount of liquid agent etc. required for the application chosen will then be dispensed through these dispensing systems.

The washer-disinfector is supplied as standard with two internal dispensing systems:

- Dispensing system DOS 1 (blue) to dispense alkaline media, such as liquid cleaning agent. It can dispense up to 120 ml/min.
- Dispensing system DOS 3 (red) to dispense acidic media, such as neutralising agent. It can dispense up to 105 ml/min.

Up to two further optional dispensing units can be built in:

Flow rate	Media
120 ml/min	alkaline
20 ml/min	acidic

The reservoirs containing the chemical agents are placed in the top section of the drawer of the washer-disinfector.

Additional optional DOS modules:

- Dispensing system DOS S 20 to dispense acidic media such as neutralising agent. It can dispense 20 ml/min.
- Dispensing system DOS NA 120 for low-foaming disinfecting agents suitable for machine use, or for an additional cleaning agent. It can dispense up to 120 ml/min.

The reservoirs for the optional DOS modules are placed in the lower section of the drawer of the washer-disinfector.

Always place two reservoirs in the lower section of the drawer, even if only one optional DOS module is being fitted. This avoids the risk of the containers tipping over when the drawer is opened or closed.

If a dispensing system is to be used to dispense more than one type of chemical agent, the change over must only be carried out by a Miele authorised and trained service technician.

Dispensing liquid chemical agents

 Further information regarding the OXIVARIO and ORTHOVARIO programmes and connection of the H₂O₂ solution container can be found at the end of this booklet under "Special processes - OXIVARIO and ORTHOVARIO".

OXIVARIO kit:

This washer-disinfector can be set up or retro-fitted to use the OXIVARIO process by adding an additional dispensing pump and a special buffer tank for hydrogen peroxide (H₂O₂ solution).The H₂O₂ solution hose is colour coded black.

The DOS 2 dispenser is used for the H₂O₂ solution.

ORTHOVARIO kit:

This washer-disinfector can be retro-fitted to use the ORTHOVARIO process by adding a special dispensing pump to the DOS 4 dispenser in the OXIVARIO system:

- Dispensing system DOS 4 (green) to dispense a special tenside cleaning agent. It can dispense up to 120 ml/min.

If the ORTHOVARIO process is used chemical disinfecting agents cannot be used in the DOS 4 dispenser.

Dispensing systems

The agents can be filled into 5 l plastic containers, which are colour coded for the relevant dispensing system.

 Take great care when handling liquid agents and additives. These may contain irritant or corrosive ingredients. Please follow the manufacturer's instructions and wear protective gloves and goggles.

"Fill DOX [X] container" message

- Refill the container referred to in the display or replace it with a new, full container.

[x] The display will show the number of the dispensing unit instead of the X.

Refill the appropriate container according to the message shown in the display, e.g. **Fill DOS1 container**. This will prevent the unit becoming empty and so avoid the necessity of venting the dispensing system.

Dispensing liquid chemical agents

Fill the containers with the relevant agent

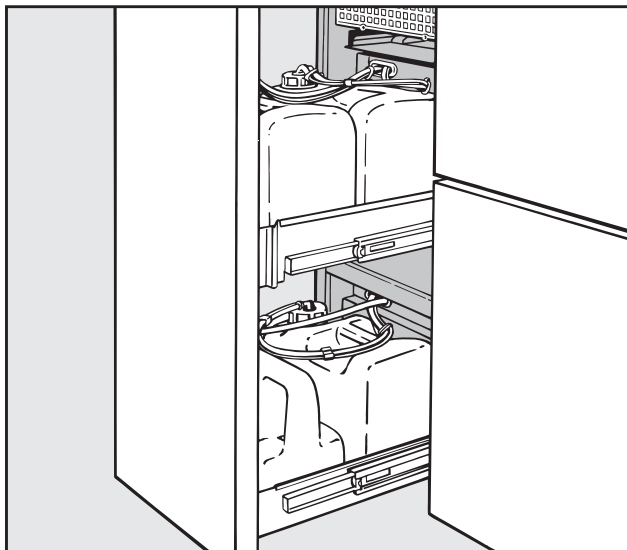

- Open the DOS drawer to access the liquid agent containers.
- Remove the container and place on the open door of the washer-disinfector.

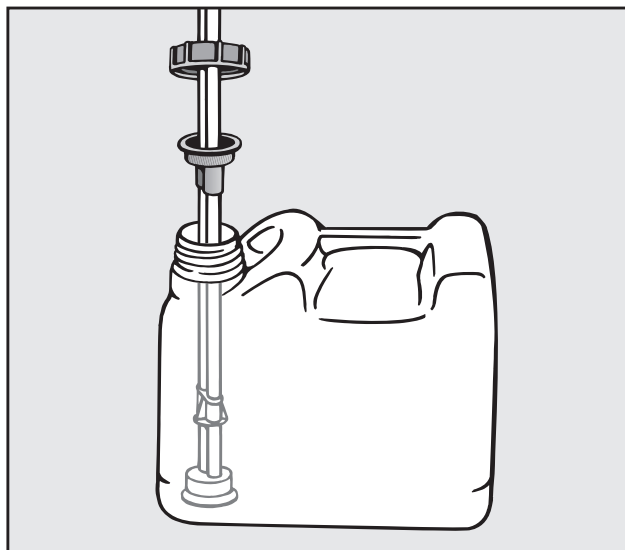

- Open the container and fill with the desired chemical agent, paying attention to the colour-coded labelling.
- Insert the siphon tube into the container and screw on securely (observing the colour code).

Once the storage containers have been filled the relevant message goes out.

- Place the container in the DOS drawer and close the DOS drawer.

Dispensing liquid chemical agents

"Check dispensing system [X]"

The programme currently running will be cancelled.

- Check the container referred to in the message and the dispensing hoses.

[x] The display will show the number of the dispensing unit instead of the X.

- If necessary, refill an empty container or replace it with a new, full container.
- Vent the dispensing hoses of the dispensing system referred to in the display with the appropriate Service programme.

The level query for dispensing systems which are not being used can be turned off to avoid the error message (see "Machine functions / container query" in the Programming manual supplied with the washer-disinfector).

Venting the dispensing system

If a dispensing system has been emptied completely, it must be vented after the container has been filled.

- Select the appropriate Service programme, e.g. **DOS1-FILL**.
- Press the Start button .

 The cancelled programme will need to be repeated.

Switching on

- Open the stopcocks (if turned off).
- Press button  for at least 1.5 seconds.

The length of time for which the  button can be pressed is set at a maximum of 10 seconds (see Programming manual "System functions/How long you can press the On/Off button").

- In operating levels A, B and D the most recently selected programme appears in the display and in operating level C, instructions for **Automatic mobile unit recognition** is displayed.

The display will switch off automatically after approximately 10 minutes when the washer-disinfector is not in operation. Press any button to switch the display back on again.

Reset button

If the machine stops reacting to buttons being pressed use the reset button.

The reset button is situated underneath the electronic control unit. To operate it:

- Open the DOS drawer.
- Press the reset button.

This shuts down the profitronic unit and then restarts it.



Starting the programme

See the Programme charts in the Programming manual supplied with the machine for detailed information and important notes on the standard Miele programmes.

 When reprocessing medical devices, any changes made to programmes or dispensing systems must be documented in a log book kept with the machine (in accordance with the Medical Device Directive). The machine's cleaning and disinfecting standards must also be re-validated.



Operating levels A and B

A list of all the available programmes will appear.

- Select the programme required with   and confirm with **OK**.
- Press the Start button .

The programme will proceed.

Operating level D

- Select the **Programme overview** option and confirm your selection with **OK**.
- Select the programme required with   and confirm with **OK**.
- Press the Start button .

The programme will proceed.

Operation

Operating level C

⚠ Make sure that there are no small metallic objects or instrument parts attracted to the magnetic strip, in particular to the underside of it. Any metallic objects on the strip can result in the coding being incorrectly read.

⚠ Before starting a programme by pressing the Start button, it is **absolutely essential** that you check that the programme shown in the display is the correct one for the mobile unit being used. Otherwise inadequate cleaning or disinfection could be the result. Please make sure that mobile units used for automatic mobile unit recognition are correctly coded.

- Push the coded mobile unit into the washer-disinfector.
- Close the door.
- Press the Start button .

The programme will proceed.

Programme sequence

The programme will start automatically as soon as the Start button has been pressed.

The programme stage reached will be shown in the display as the programme proceeds.

Detailed information on programme sequences is given in the appendix to the Programming Manual.

At the end of the programme

- **Programme finished** will appear in the display at the end of a programme.

Switching off

- Press button .

If the machine is not going to be used for several days the water stopcocks should be turned off and the machine should be disconnected from the mains electricity supply.

Cancelling a programme

A programme can only be cancelled in operating level B or D.

When testing to EN ISO 15883-1 or HTM 2030 standards, a programme must not be interrupted or cancelled.

In operating levels B or D

- Press button **◀C**.

The programme will be interrupted.

If the water temperature is below 40 °C the following will appear in the display:

**Cancel programme (OK)
or continue (Clear)?**

If the water temperature is above 40 °C:

Cancel programme (OK)?

 With established decontamination programmes any contaminated water must be decontaminated using a disinfecting agent before it is discharged into the sewerage system. Only then can the door be opened.

If a great deal of hot water is present in the wash cabinet when the programme is interrupted and the door is then closed quickly, hot water can escape.
Danger of burning or scalding.

- Confirm with **OK**.

**Programme cancelled,
Water drainage** will appear in the display.

After the water has been pumped away, the display will show the list of programmes again.

Operation

Interrupting a programme

A programme can only be interrupted in operating level B or D.

If you absolutely have to open the door, e.g. because the load is obviously unstable or to check the cleaning performance (conscious intervention):

After interrupting a programme with defined process requirements, if you wish to continue it, please check the message in the display at the end of the programme. If the message **Process parameters not achieved** appears, it means that the door was opened **after** the process parameter monitoring had begun and so the defined process requirements were not fulfilled. If necessary, the programme must be repeated.

In operating levels B or D

- Press button ◀C.

If the water temperature is below 40 °C the following will appear in the display:

Cancel programme (OK)
or continue (Clear)?

If the water temperature is above 40 °C:

Cancel programme (OK)?

- Open the door.

⚠ Caution. Water and items in the machine may be hot. Danger of burning or scalding.

Where a chemical disinfection programme has been used, be aware that steam may contain high quantities of disinfecting agent.

- Rearrange the load. Follow infection control regulations and wear protective gloves.
- Close the door carefully.

⚠ If there is a lot of hot water in the wash cabinet when the programme is interrupted and the door is then closed quickly, hot water can escape.

Danger of burning or scalding.

If the water temperature is lower than 40 °C when the programme is interrupted:

- Press button ◀C.

The programme will continue.

If the water temperature is higher than 40 °C when the programme is interrupted:

- Press the **OK** button.

The programme will be cancelled.

Programme cancelled,
Water drainage will appear in the display.

Once the water has been pumped away, the programme can be restarted.

This washer-disinfector can be set up to document processes used.

This can be recorded by either using external software for process documentation or an external printer.

The washer-disinfector is equipped with two RJ45 connectors on the back for connecting to Process documentation software or a printer.

The interface configuration is described in section "PC/Printer function" of the Programming manual.

Process documentation using external software

The "Ethernet" connection is used for transferring process reports and temperature graphs to the external software.

A straight-through ethernet cable is required for connecting the washer-disinfector with suitable network components (e.g. hub, switch).

A cross-over ethernet cable is required for a direct ethernet connection between the washer-disinfector and an external appliance.

Process documentation using an external printer

The connector marked "Printer" is used for connecting an external printer to the serial interface.

An RJ45 / Sub-D adapter is needed for connecting the washer-disinfector to the external printer via an RS 232 interface.

Instructions on how to set the print functions of an external printer are given in section "PC/Print functions" in the Programming manual.

Please note the following when connecting a printer or PC:

- Only use an industry-standard PC or printer (EN/IEC 60950, Australia and New Zealand: AS/NZS 60950).
- The size of the printer or PC must be taken into account when installing the machine.
- The maximum length for an extension cable from the serial interface to the printer or PC is 10 m and from the ethernet interface 100 m.

Please contact Miele if you require further information about suitable printers and software.

Maintenance

Periodic checks

This washer-disinfector should be inspected in accordance with local and national safety regulations after **every 1000 operating hours, or annually** by a Miele approved service technician.

This maintenance will cover the following:

- Electrical safety tests
- Door mechanism and door seal
- Any screw connections and connectors in the wash cabinet
- Water inlet and drainage
- Internal and external dispensing systems
- Spray arms
- Filter combination
- Sump including drain pump and non-return valve
- Steam condenser
- All mobile units, baskets and inserts
- The drying unit

and where applicable:

- Any printer connected to the machine

The following operational tests will be carried out within the framework of the maintenance:

- A programme will be run as a test run
- Thermo electrical measurements will be taken

- Seals will be tested for water tightness
- All relevant measuring systems will be safety tested including error message displays
- All safety mechanisms.

Process validation

The standard of cleaning and disinfection in the disinfection programmes must be confirmed by the user as a routine matter. In some countries, national regulations, guidelines and recommendations also apply (e.g. CfPP 01-01, Part D in the UK).

In the UK safety checks must be carried out to the machine every 3 months by a Miele approved service technician in accordance with **EN ISO 15883** and **HTM 2030**.

Routine checks

Before the start of each working day the user must carry out a number of routine checks. A check list is supplied with the machine for this purpose.

The following need to be inspected:

- All filters in the wash cabinet
- The spray arms in the machine and in any mobile units or modules
- The wash cabinet and the door seal
- Mobile units, baskets and inserts

Cleaning the filters in the wash cabinet

The filters in the base of the wash cabinet are designed to prevent coarse soiling getting into the circulation system.

A build-up of coarse soiling can cause the filters to clog up. They should, therefore, be checked daily and cleaned if necessary.

 This machine must not be used without all the filters in place.

 Watch out for glass splinters, needles etc. on the filters in the wash cabinet. Danger of injury.

Cleaning the coarse filter

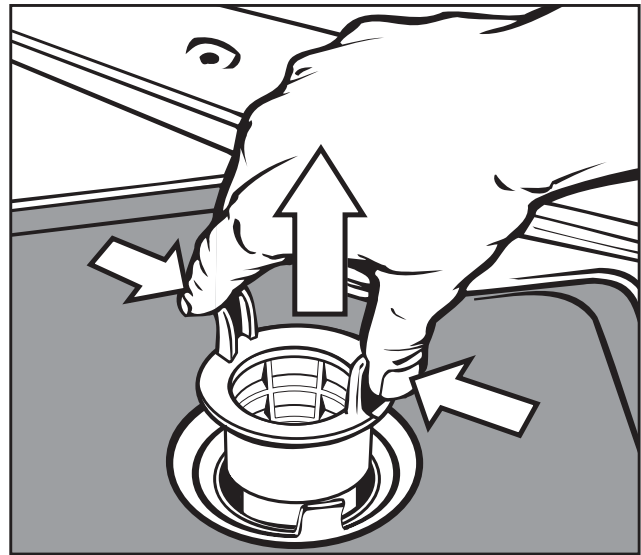

- Press the two lugs together, remove and clean the coarse filter.
- Put the clean filter back in position and press until it clicks in place.

Maintenance

Cleaning the coarse, flat and micro-fine filters

- Remove the coarse filter.
- Remove the fine filter (if fitted) from between the coarse and the micro-fine filters.

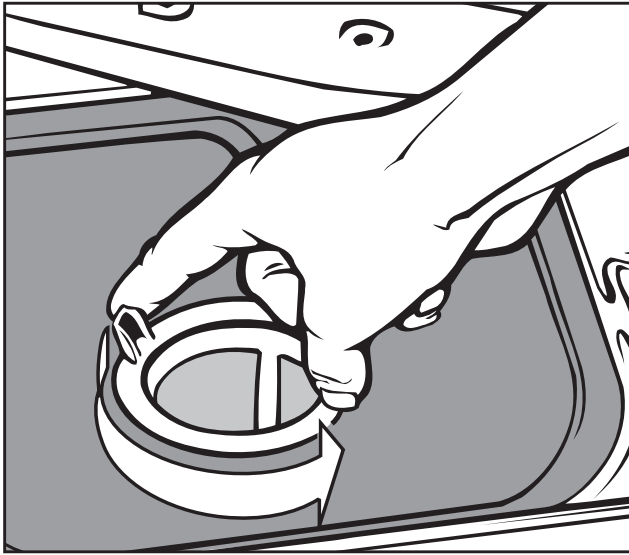

- To unscrew the micro-fine filter, take hold of the two lugs and turn twice in an anti-clockwise direction.

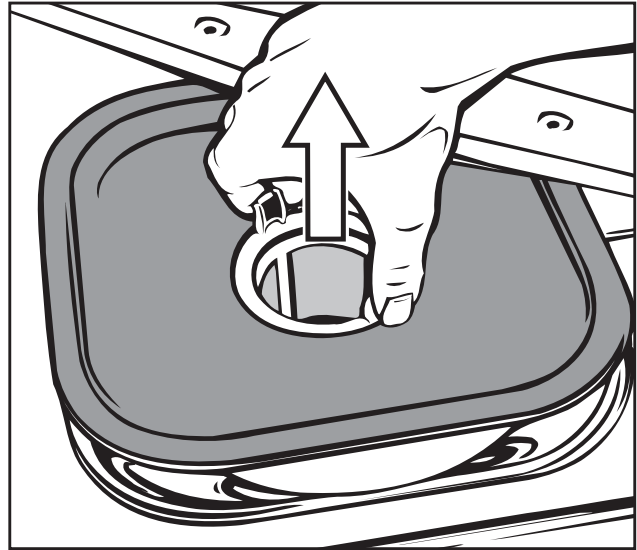

- Then remove together with the flat filter.
- Clean the filters.
- Replace the filters by carrying out the above steps in the reverse order. Ensure that the flat filter sits flat in the base of the wash cabinet.

Cleaning the spray arms

The spray arms can become blocked and should therefore be checked every day.

- Use a sharp pointed object to push particles into the spray arm jets, and rinse well under running water.

Remove the spray arms as follows:

- Take any baskets out of the wash cabinet.

Spray arm on top basket or mobile unit (if present):

- Loosen the nut on the spray arm and take the spray arm off.

Metal nuts have a left-hand thread.
Ceramic nuts have a right-hand thread.

- Unscrew the **upper** spray arm.
- Loosen the knurled thumb nut to unscrew the **lower** spray arm.
- After cleaning the spray arms, fit or screw them back into position.

After replacing the spray arms, check that they rotate freely.

Maintenance

Cleaning the control panel

- Switch the washer disinfectant off with the  button.
- The controls should only be cleaned using a damp cloth or with a proprietary cleaning agent for glass surfaces.
An approved and listed surface disinfecting agent can be used to wipe surfaces.

 Do not use abrasive cleaners or all-purpose cleaners. Because of their chemical composition they could cause serious damage to the glass surface.

Cleaning the front of the machine

- The front should be cleaned using a damp cloth and a little washing-up liquid, or with a non-abrasive proprietary cleaning agent designed for use on stainless steel.
- To help prevent resoiling (fingermarks etc.) a stainless steel conditioning agent (available from the Miele Spare Parts Department or via the Internet, depending on country) can also be used.

 Do not use any cleaning agents containing ammonia or thinners as these can damage the surface material.

 Never clean the machine or near vicinity with a hose or a pressure washer.

Cleaning the wash cabinet

The wash cabinet is generally self-cleaning.

However, should a build-up of deposits occur in the cabinet please contact Miele for advice.

Cleaning the door seals

The door seals should be cleaned regularly with a damp cloth to remove any soiling.

Seals which are no longer tight or which have suffered damage must be replaced with new ones by an approved Miele technician.

Mobile units, baskets and inserts

Mobile units, baskets and inserts should be checked daily to make sure they are functioning correctly. The washer-disinfector is supplied with a check list.

The following need to be inspected:

- Check that the guide rails on mobile units/inserts are free of hindrance and that they are secured to the mobile units/inserts correctly.
- Check that the mobile unit connector is at the correct height and screwed on correctly.
- Check that the locking caps in the module connectors of modular system mobile units are working properly.
- Check that jets, sleeves and hose adapters are securely held in position in mobile units/inserts.
- Check that washing solution can flow unhindered through all jets, sleeves and hose adapters.
- Make sure caps and closures on sleeves are correctly located.

and where applicable:

- Make sure that the spray arms rotate freely.
- Make sure the spray arm jets are free of any blockages. See "Cleaning the spray arms".
- Check whether there are magnets on the ends of the spray arms.
- Make sure no metal parts have been attracted to the magnets on the ends of the spray arms.
- Make sure that there are no small metallic objects sticking to the magnetic strip on a mobile unit.
- Check that the magnetic strip on mobile units with automatic mobile unit recognition is correctly screwed into position.

In line with the periodic maintenance of the washer-disinfector the mobile units, modules and inserts should be routinely serviced **every 1000 operating hours or annually** by a Miele approved service technician. See "Maintenance / Periodic checks".

Maintenance

Drying unit (TA) - Maintenance

Changing the coarse filter

The coarse filter should be changed when the message **Change coarse filter** appears in the display.

- Open the front of the control unit cabinet.

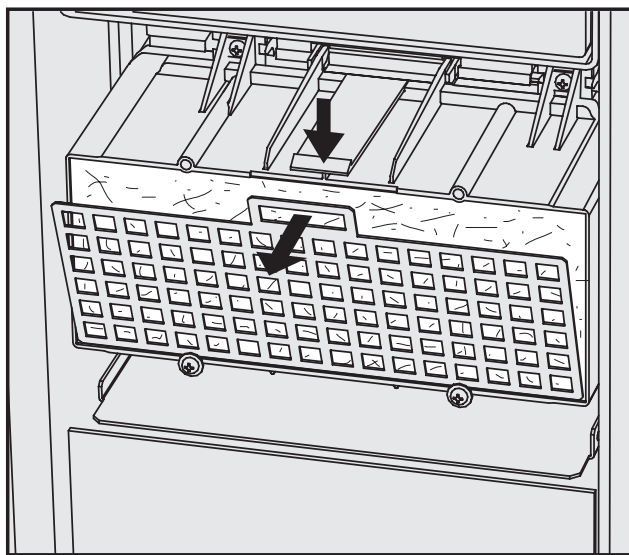

- Remove the filter grille from the drying unit.

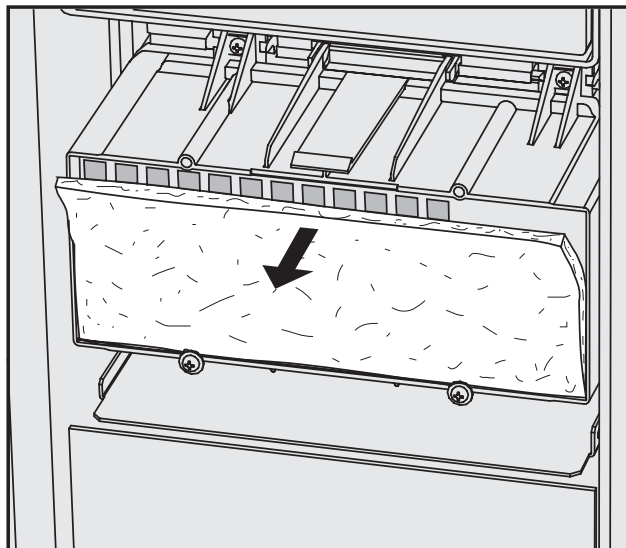

- Replace the coarse filter. The soft side of the filter must face the front.
- Replace the filter grille and push it upwards to secure it.
- Close the front of the control unit cabinet.

After replacing the coarse filter, the operating hours counter must be reset.

To do this:

- Select the **CHANGE-TA-COARSE** programme and press \diamond to start it.

When the service programme has ended, a message will appear in the display.

- Confirm this message by pressing the **OK** button.

The programme overview will then appear in the display.

Changing the fine filter

- The HEPA filter should be changed when the message **Change fine filter** appears in the display.

To ensure the machine operates correctly, use **original Miele HEPA filters** only (classification 13).

It is advisable to have the fine filter changed whenever the machine is serviced.

If it needs changing before this:

- Open the front of the control unit cabinet.
- Loosen the top securing screws on the coarse filter housing and hinge them upwards.

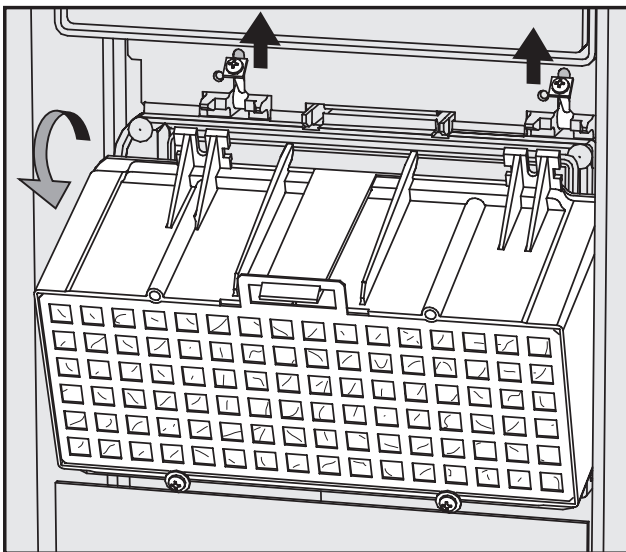

- Remove the coarse filter housing.

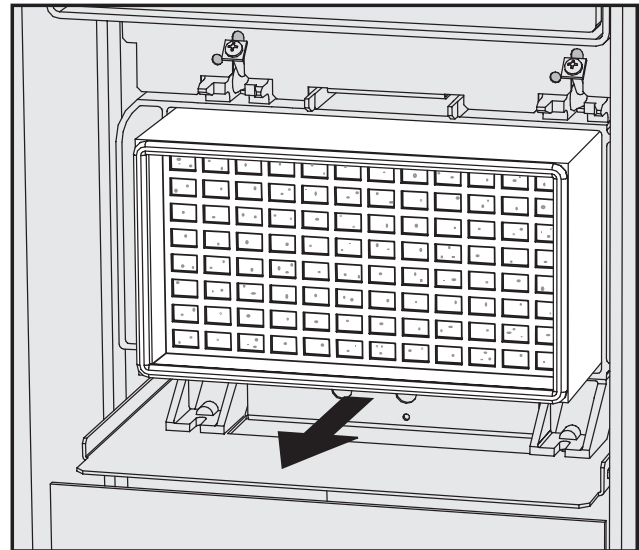

- Pull the fine filter out of its holder and replace it with a new one.
- Replace the coarse filter housing, and hinge the securing screws back downwards.
- Tighten the securing screws.
- Close the front of the control unit cabinet.

After cleaning and replacing the HEPA filter, the operating hours counter must be reset.

To do this:

- Select the **CHANGE-TA-FINE** programme and press \diamond to start it.

When the service programme has ended, a message will appear in the display.

- Confirm this message by pressing the **OK** button.

The programme overview will then appear in the display.

Problem solving

Thermal cut-out

This machine has a resettable heater limiter which will shut off the heating elements in the event of over-heating. This could be caused, for example, by large articles covering the heating elements or if the filters in the wash cabinet are blocked.

If the message "Check wash cabinet heating" appears (water has not heated up in the wash cabinet and the programme is taking too long), proceed as follows:

- Remove the cause of the fault.
- Take off the service panel.
- Press the reset button on the heater limiter located on the right-hand side of the plinth.

If this switch trips again contact the Miele Service Department.

Cleaning the filters in the water inlet

Filters are incorporated in the screw connection of the water inlet hose to protect the water inlet valve. If these filters get dirty they need to be cleaned, otherwise insufficient water flows into the wash cabinet.

 The plastic housing of the water connection contains an electrical component. It must not be dipped in water.

To clean the filter

- Disconnect the machine from the mains electricity supply
- Turn off the stopcock and unscrew the water inlet hose.

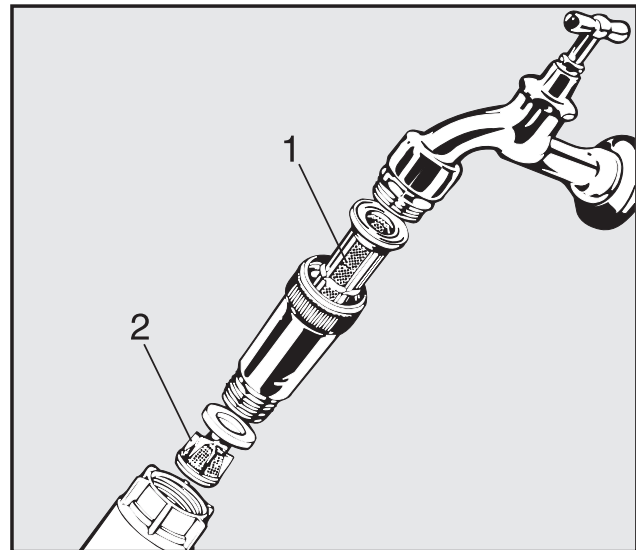

- Clean the large area filter (1) and fine filter (2), and replace with new filters if necessary.
- Replace filters and the seal. Make sure they are sitting correctly.
- Reconnect the inlet hose to the stopcock, making sure it goes on correctly and is not cross-threaded.
- Open the stopcock gradually to test for leaks.

If water leaks out the connection may not be tight enough or the hose may have been connected incorrectly.

- Reconnect the hose correctly and tighten it.

After sales service

 Repairs should only be carried out by a suitably qualified and trained Miele technician in accordance with local and national safety regulations. Unauthorised or incorrect repairs and other work by unqualified persons could be dangerous.

To avoid unnecessary service call-outs, check that the fault has not been caused by incorrect operation when an error message first appears.

An overview of all **error messages** that can appear in the display is given in the Programming Manual under "Messages".

If, having followed the advice in the operating instruction manual, you are still unable to resolve a problem please call the Miele Service Department (see the end of this booklet for contact details).

N.B. A call-out charge will be applied to service visits where the problem could have been resolved as described in these instructions.

When contacting Miele, please quote the model and serial number of your machine.

These are located on the data plate (see "Electrical connection").

 Please refer to the installation diagram supplied with the machine.

 Furniture and fittings installed near the machine must be of a commercial standard able to withstand the effects of steam and condensation.

The machine must be installed correctly and levelled.

Any unevenness in the floor level can be compensated for and the height of the machine raised or lowered by adjusting the four screw feet.

When the feet are screwed in, the machine can be moved backwards and forwards on rollers.

Electrical connection

 All electrical work must be carried out by a suitably qualified and competent person in accordance with current local and national safety regulations (BS 7671 in the UK).

- If the machine is connected via a plug and socket, the plug connection must be easily accessible. Plug connection will also make it easier to carry out mandatory safety checks, e.g. after commissioning or maintenance.
- For hard-wired machines connection should be made via a suitable isolator, with an on-off switch which is easily accessible for servicing and maintenance work after the machine has been installed. An electrical safety test must be carried out after installation and after any servicing work. It is therefore essential that the on-off switch is easily accessible.
- When switched off there must be an all-pole contact gap of at least 30 mA in the isolator switch.
- For extra safety it is advisable to protect the machine with a suitable residual current device.
- The mains connection cable may only be replaced by an original Miele spare part or an appropriate cable with wire end ferrules.
- Check that the phase rotation is correct when connecting the machine. Failure to do so could have an adverse effect on the circulation pump and impair the wash quality.

- Equipotential bonding must be carried out.
- For technical data see data plate or wiring diagram supplied.

The machine must only be operated with the voltage, frequency and fusing shown on the **data plate**.

The **wiring diagram** is supplied with the machine.

WARNING THIS APPLIANCE MUST BE EARTHED

Bonding connection

There is a screw connection point marked with the earth symbol () at the back of the machine, to which the earth lead must be connected.

Connection to the water inlet

 The water in the machine must not be used as drinking water.

- The machine must be connected to the water supply in accordance with local and national water authority regulations.
- If the water supply has a high iron content there is a danger of corrosion occurring on items being processed in the machine, as well as in the machine itself.
If the chloride content of the water exceeds 100mg/l the risk of corrosion to items being processed in the machine will be further increased.
- This machine is constructed to comply with German water regulations (DVGW), and may be connected to a suitable supply without an extra non-return valve if national regulations permit.
- The **minimum flow pressure** for a cold and hot water connection is 150 kPa and with an AD water connection it is 60 kPa.
- The **recommended flow pressure** for a cold and hot water connection is ≥ 250 kPa and for an AD water connection is ≥ 150 kPa. Otherwise fill times will be too long.
- The **maximum permitted static water pressure** is 1000 kPa.
- If the water pressure is not in the range specified above, please contact the Miele Service Department for advice.
- The machine is supplied as standard for connection to a cold (coded blue) and a hot (coded red) water supply up to a max. temperature of 70 °C. The inlet hoses should be connected to the stopcocks for the hot and cold water supplies. The steam condenser inlet hose (without waterproof connector) should be connected to the cold water stopcock.
- If a hot water supply is not available the inlet hose coded **red** should also be connected to the cold water stopcock. AD-water connection (marked H₂O pur) see next page.
- Stopcocks with 3/4 BSP male thread are to be provided on site. They should be easily accessible so that the water supply can be turned off when the machine is not in use.
- The DN 10 inlet hoses are approx. 1.7 m long terminating in a 3/4 inch female thread. On no account must the inlet filters be removed.

Plumbing

- Large surface area filters are enclosed in the kit supplied with the machine for installing between the stopcock and the inlet hose (see illustration in Problem solving - "Cleaning the filters in the water inlet"). The large surface area filter is made from chrome nickel steel and can be recognised by the matt top surface.

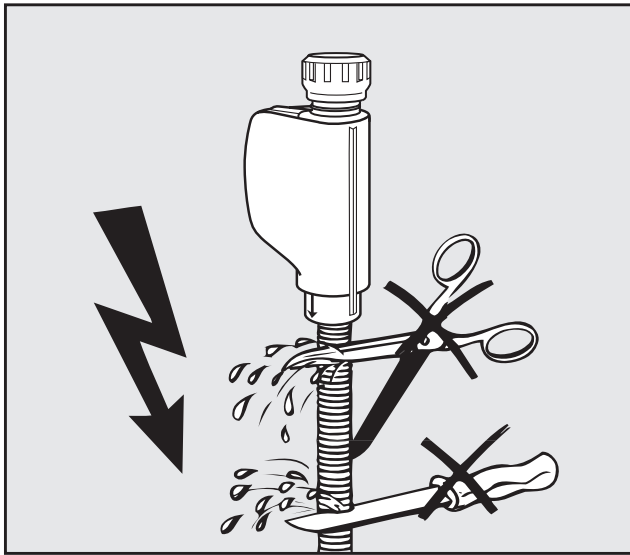

⚠ The inlet hoses must **not** be shortened or damaged in any way (see illustration).

See also the installation diagram supplied.

AD water connection (pressurised) > 60 - 1000 kPa over pressure

The machine is supplied as standard for connection to an AD water supply of 60 - 1000 kPa. If the water pressure (flow rate) is below 150 kPa the water intake time is automatically extended.

- The AD pressure tested hose (marked "H₂O pur") with a 3/4" threaded union must be connected to the on-site AD stopcock for purified water.

⚠ Note: If the machine is not going to be connected to an AD water supply, the cleaning and disinfecting programmes will have to be altered by a Miele Service technician. The inlet hose will remain on the rear of the machine.

Optional AD water connection (without pressure) 8.5 - 60 kPa

The appliance **must** be converted (special accessory) (if this has not already been done at the factory) before connecting to a water supply 8.5 - 60 kPa. The feed pump must be fitted by a Miele service technician only.

When connecting an AD water container (without pressure) the drain connection must be at least the height of the upper edge of the machine (see "Installation instructions").

IMPORTANT

Australia and New Zealand

This appliance must be installed according to AS/NZS 3500.1.
This appliance has been supplied with a separate backflow prevention device.

This machine must be connected to the potable water supply via the non-return valve (check valve) supplied with the machine.

Before making plumbing connections, ensure the appliance is disconnected from the main power supply (switch off or unplug the power).

- Turn off the mains water tap.
- Place the seals on both sides of the non-return valve.
- Connect the female end of the non-return valve to the water tap.
- Connect the filter to the male end of the non-return valve.
- Connect the inlet hose to the filter.

Ensure that all connections are screwed into position correctly. The connection points are subject to mains water pressure.

- Turn on the tap slowly and check for leaks.

Correct the position of the seal and union if necessary.

Plumbing

Drainage

- The drainage system is fitted with a non-return valve which prevents dirty water from flowing back into the machine via the drain hose.
- The machine should preferably be connected to a **separate** drainage system on-site.
If separate drainage is not available contact your Miele application specialist for professional advice.
The on-site drain connection point should be sited between 0.6 m and 1 m above the lower edge of the machine.
If it is lower than 0.6 m lay the hose in a curve at a height of at least 0.6 m.
The drainage system must be able to take a minimum drainage flow of 50 l/min.
- The drain hose is approx. 1.5 m long, is flexible and has an internal diameter of 22 mm. It must not be shortened.
Hose clips are supplied for securing it in position.
- A longer drain hose (up to 4 m long) is available to order from the Miele Spare Parts Dept.
- The drainage system must not exceed 4 metres.

See also the installation diagram supplied.

Technical data

Height	117.5 cm
Width	90 cm
Depth	70 cm
Depth with door open	126.5 cm
Weight (net)	180 kg
Voltage, connected load, fuse rating	See data plate
Mains cable	Approx. 1.8 m
Water temperature: Cold water	max. 20 °C
Hot and AD water	max. 70 °C
Static water pressure	Max. 1000 kPa (10 bar) pressure
Minimum flow pressure:	
Cold/hot water inlet connections	100 kPa pressure
AD water connection	60 kPa pressure
Recommended flow pressure:	
Cold/hot water inlet connections	≥ 250 kPa pressure
AD water connection	≥ 150 kPa pressure
AD-water connection (non-pressurised)	optional, 8.5 -50 kPa
Delivery head	min. 0.6 m, max. 1 m
Steam condenser	Approx. 2 - 4 l/min
Ambient temperature	5 °C to 40 °C
Relative humidity	80 % for temperatures to 31 °C
Decreasing proportionately to	50 % for temperatures to 40 °C
Altitude	Max. 1500 m #
Degree of soiling	P2 (according to IEC/EN 61010-1)
Protection category (according to IEC 60529)	IP20 (Dust permeation)
Noise level in dB (A), Sound level LpA during cleaning and drying phases	< 70
Test marks	VDE, radio interference suppression
CE mark	MDD-Guidelines 93/42/EWG, Class IIb
Manufacturer's address	Miele & Cie. KG, Carl-Miele-Str. 29, 33332 Gütersloh, Germany

If installed at altitudes above 1500 m the boiling point of the suds solution will be lower. Disinfecting temperature parameters should be lowered and the holding time increased (A_0 value). This must be done by a Miele authorised service technician.

Optional extras

Options

- Fitting kit for DOS S 20 and DOS NA 120 dispensing systems
- Connecting module AM10
- Conductivity measurement module

Special processes - OXIVARIO and ORTHOVARIO

Intended use

This washer disinfectant can be set up or retro-fitted to use the OXIVARIO process by adding two additional dispenser pumps together with a buffer tank for hydrogen peroxide solution H_2O_2 . The DOS 2 dispenser is used for the H_2O_2 solution.

To use the ORTHOVARIO process the DOS 4 dispensing system has to be fitted with a dispenser pump for a tenside based cleaning agent.

The OXIVARIO, OXIVARIO PLUS and the ORTHOVARIO programmes are available for these requirements. The machine is supplied with these programmes allocated to programme places 51 to 53.

The OXIVARIO process releases active oxygen under alkaline conditions. The cleaning agent used must be tenside free and have a pH value of between 11 and 11.5.

The ORTHOVARIO process uses a special tenside based cleaning agent in the first cleaning phase and then releases active oxygen in the second phase with a pH value of between 10.0 and 11.0 and a slightly higher temperature of 65 °C.

Areas of application

The **OXIVARIO** procedure has an alkaline main wash making it particularly suitable for the reprocessing of surgical instruments where existing procedures are not satisfactory.

It is particularly suitable for instruments such as those used in high frequency surgery, orthopaedic surgery as well as for instruments which have dried out because of the length of time between using them and reprocessing them. It is also suitable for antiseptic circumstances.

The OXIVARIO PLUS process is designed to prevent transmission of iatrogenic prions (vCJD).

The cleaning process is gentle enough for instruments used in minimally invasive surgery, including fibre optics, where the manufacturer has declared that they are suitable for reprocessing with an alkaline cleaning agent.

It is not suitable for anodised aluminium.

Be aware that items made from alloys containing titanium such as some implants, do not always state the material's compatibility. Reprocessing such items can result in colour changes, rendering any coding on them ineffective. If in doubt please consult the manufacturer of the item.

The **ORTHOVARIO** procedure is suitable for reprocessing aluminium instruments which are sensitive to alkalines. It is particularly suitable for orthopaedic instruments including motor systems.

Because of its oxidising effect it must not be used for titanium implants, and in particular colour coded ones.

Special processes - OXIVARIO and ORTHOVARIO

 Due to the high efficacy of the Oxivario and Orthovario processes it is important to lubricate joints and contact parts on instruments pre sterilisation. Please refer to the instrument manufacturer for guidance.

Warning and Safety instructions

 These warning and safety instructions are in addition to those given at the beginning of this booklet.

- ▶ H₂O₂ solution must only be used in the special containers and adapters provided by the Ecolab or Dr. Weigert companies.
- ▶ Please observe safety instructions (safety data sheets) provided by the chemical agent manufacturer.
- ▶ Be especially careful when handling H₂O₂ solution. It is an irritant chemical. Observe all current safety instructions pertaining to its use. Wear protective gloves and goggles.
- ▶ Empty containers must be disposed of in accordance with the manufacturer's instructions.
- ▶ H₂O₂ solution must not be mixed with other chemicals. This could cause a serious chemical reaction, e. g. the release of harmful vapours or gases.
- ▶ Only use tenside cleaning agents supplied by Ecolab or Dr. Weigert.

Connecting the H₂O₂ solution container

The connection hose for the H₂O₂ solution container is identified by a black label. The connection hose is supplied without a safety cap as the container for hydrogen peroxide will vary depending on supplier.

- Connect the supplier's safety cap to the connection hose (black).
- Then connect this to the H₂O₂ solution container.
- Then start the **DOS2-FILL** programme.

Unlike with other chemical agents the H₂O₂ solution container must be fully emptied before it is exchanged for a new one.

Do not replace the H₂O₂ solution container with a new one until the **FILL DOS 2 CONTAINER** message is displayed. After connecting the new container you must run the **DOS2-FILL** programme.

If the **CHECK DISPENSING SYSTEM 2** message appears you should check the container as well as the dispensing system. The programme will stop automatically.

Disposal of your old machine

Electrical and electronic machines often contain materials which, if handled or disposed of incorrectly, could be potentially hazardous to human health and to the environment. They are, however, essential for the correct functioning of your machine. Please do not therefore dispose of it with your general waste.

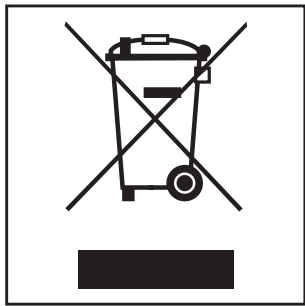

Please dispose of it at your local community waste collection / recycling centre or contact your dealer for advice. Ensure that it presents no danger to children while being stored for disposal.

United Kingdom

Miele Co. Ltd.
Fairacres, Marcham Road
Abingdon, Oxon, OX14 1TW
Professional Sales, Tel: 0845 365 6608
E-mail: professional@miele.co.uk
Internet: www.miele.co.uk/professional

Australia

Miele Australia Pty. Ltd.
ACN 005 635 398
ABN 96 005 635 398
1 Gilbert Park Drive, Knoxfield, VIC 3180
Tel: 1300 731 411
Internet: www.miele-professional.com.au
E-mail: info@miele-professional.com.au

China

Miele (Shanghai) Trading Ltd.
1-3 Floor, No. 82 Shi Men Yi Road
Jing' an District, 200040 Shanghai, PRC
Tel: +86 21 6157 3500, Fax: +86 21 6157 3511
E-mail: info@miele.cn, Internet: www.miele.cn

Miele (Hong Kong) Limited

41/F - 4101, Manhattan Place
23 Wang Tai Road
Kowloon Bay, Hong Kong
Tel: (852) 2610 1025, Fax: (852) 3579 1404
Email: customerservices@miele.com.hk
Website: www.miele.hk

India

Miele India Pvt. Ltd.
Ground Floor, Copia Corporate Suites
Plot No. 9, Jasola
New Delhi - 110025
Tel: 011-46 900 000, Fax: 011-46 900 001
E-mail: customercare@miele.in, Internet: www.miele.in

Ireland

Miele Ireland Ltd.
2024 Bianconi Avenue
Citywest Business Campus, Dublin 24
Tel: (01) 461 07 10, Fax: (01) 461 07 97
E-Mail: info@miele.ie, Internet: www.miele.ie

Manufacturer: Miele & Cie. KG
Carl-Miele-Straße 29, 33332 Gütersloh, Germany



Miele
PROFESSIONAL

Malaysia

Miele Sdn Bhd
Suite 12-2, Level 12
Menara Sapura Kencana Petroleum
Solaris Dutamas No. 1, Jalan Dutamas 1
50480 Kuala Lumpur, Malaysia
Phone: +603-6209-0288
Fax: +603-6205-3768

New Zealand

Miele New Zealand Limited
IRD 98 463 631
Level 2, 10 College Hill
Freemans Bay, Auckland 1011, NZ
Tel: 0800 464 353
Internet: www.miele-professional.com.au
E-mail: info@miele-professional.com.au

Singapore

Miele Pte. Ltd.
163 Penang Road
04 - 03 Winsland House II
Singapore 238463
Tel: +65 6735 1191, Fax: +65 6735 1161
E-Mail: info@miele.com.sg
Internet: www.miele.sg

South Africa

Miele (Pty) Ltd
63 Peter Place, Bryanston 2194
P.O. Box 69434, Bryanston 2021
Tel: (011) 875 9000, Fax: (011) 875 9035
E-mail: info@miele.co.za
Internet: www.miele.co.za

United Arab Emirates

Miele Appliances Ltd.
Gold & Diamond Park
Office No. 217-6, Sheikh Zayed Road
P.O. Box 11 47 82 - Dubai
Tel. +971 4 3044 999, Fax. +971 4 3418 852
800-MIELE (64353)
E-Mail: info@miele.ae, Website: www.miele.ae